

AURORA
PENDANT
CATALOG NO. 4



ARCO
375A

MATERIAL STAINLESS STEEL MARBLE BASE
COLORS SATIN NICKLE + WHITE/BLACK



SM375A
L2300 x W330 x H2400

ARCO



White Carrara marble base. Satin stainless steel telescopic stem. A rotatable and height-adjustable aluminum reflector that is pressed, polished, and coated with nitrocellulose. "We were thinking of a light that would illuminate the table. They already exist, but you have to get around them. In order to leave enough space around the table, the base must be at least two meters away. That's where Arco's idea comes in."







LOHJA
6250

MATERIAL
COLORS

ALUMINIUM ALLOY+PC
EARL GOLD/TITANIUM GREY/MATT WHITE



SM6250S
H3250+H2700+H2150

LOHJA

This iconic Cameron Design House pendant light is inspired by the tranquil lakes of Lohja, Finland. This contemporary design won The International Design and Architecture Award for best Pendant/Chandelier. Exploring tranquillity, space and equilibrium, the Lohja combines simplicity with geometry creating a striking, balanced sculptural form which changes appearance from each angle.
Bespoke options and design service available.





WIRELINE 2398

MATERIAL POLYURETHANE+ALUMINIUM ALLOY
COLORS ORANGE/LIGHT GRAY/LIGHT COFFEE



SM2398-3250
L1640xH3250



SM2398-2500
L1640xH2500



Suspension lamp with diffused light. Tubular in transparent extruded glass and internal diffuser in opal PC. Ferrules made with CNC technology in satin stainless steel.





FLAMINGO
2379

MATERIAL
COLORS

CARBON STEEL+ALUMINIUM ALLOY+ACRYLIC
SUMMER GOLD/SUMMER BLACK+WHITE+MATT WHITE

Suspension lamp with diffused light. Tubular in transparent extruded glass and internal diffuser in opal PC. Ferrules made with CNC technology in satin stainless steel





SM2379S1-C
Φ700 x H2000



SM2379S1-A
Φ700 x H2000



SM2379S1-B
Φ700 x H2000



SM2379S2-A
Φ900 x H2000



SM2379S2-B
Φ700 x H2000



SM2379S3
Φ900 x H2240



SM2379S4
Φ900 x H2240



SM2379S5
Φ900 x H2240



SM2379F
Φ900 x H2500



NORTH 2377

MATERIAL CARBON STEEL+ALUMINIUM ALLOY+ACRYLIC
 COLORS BLACK/WHITE



SM2377F2-C
 W600-2000xH1860
 SHADED165



SM2377F2-B
 W710-2130xH1860
 SHADED400



SM2377F2-A+C
 W1050-2390xH2830-4060
 SHADED165+D600



SM2377F2-A+B+C
 W1050-2390xH2830-4060
 SHADED165+D400+D600

NORTH



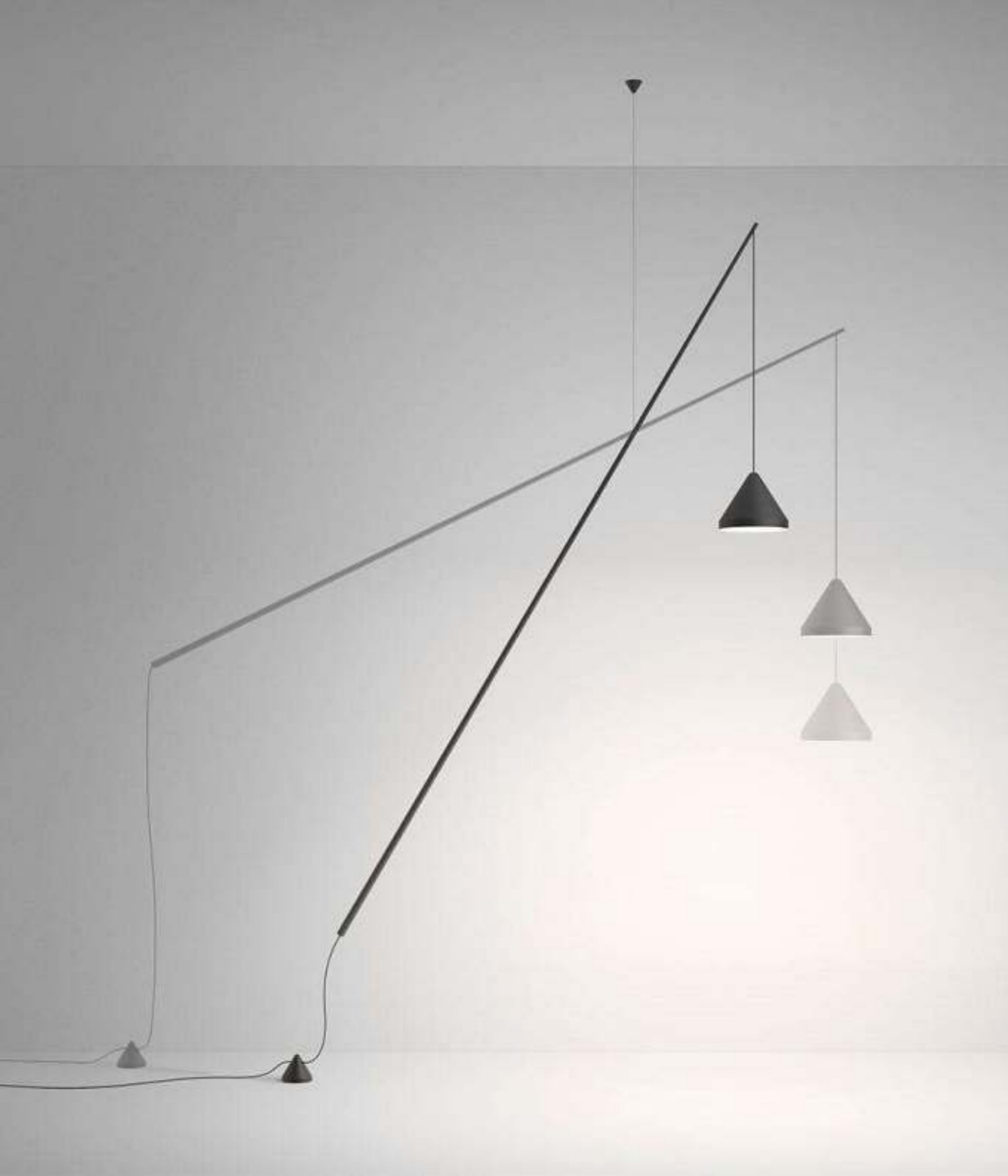

NORTH

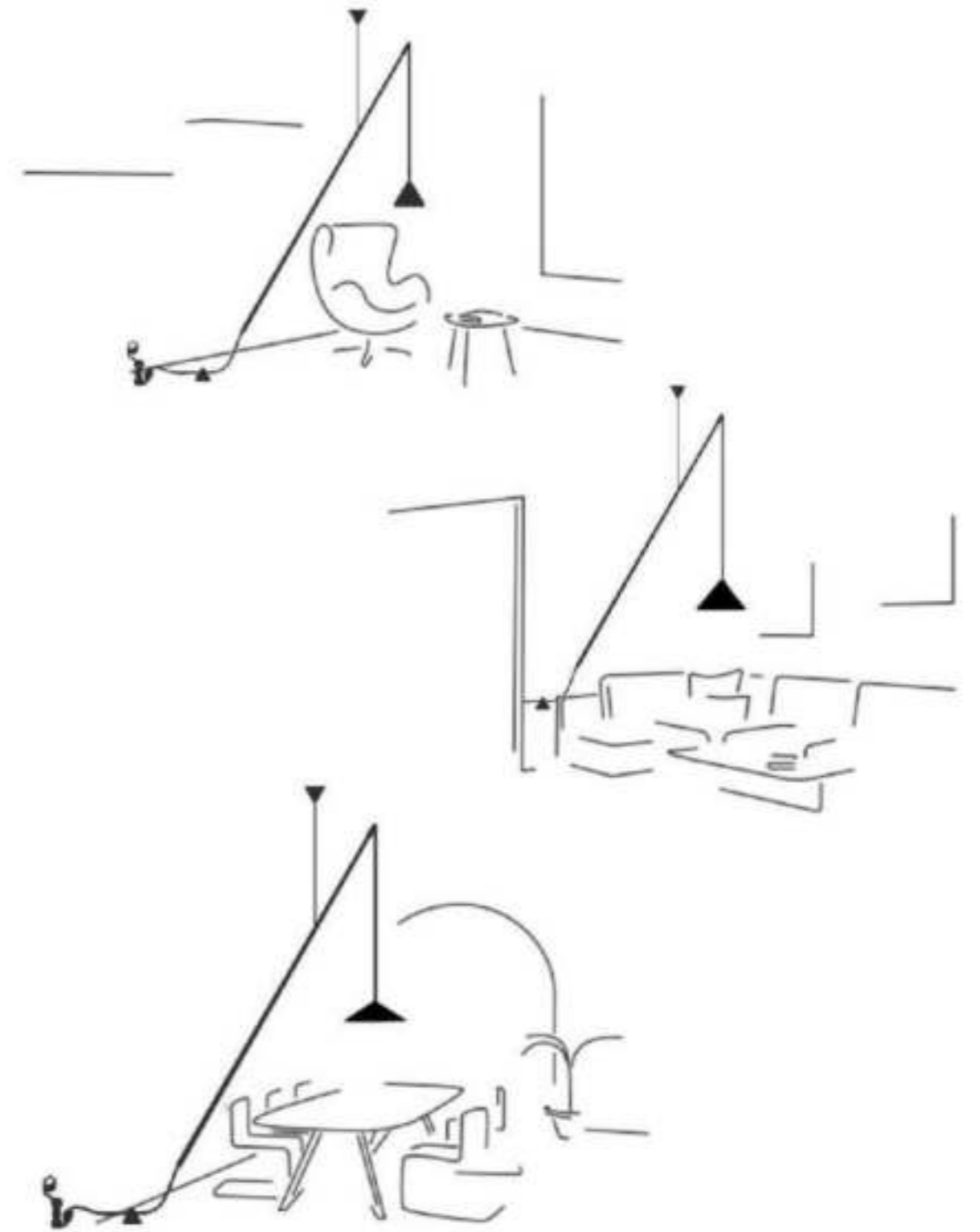



MIZU
2362

MATERIAL
COLORS

CARBON STEEL +ALUMINIUM +GLASS

CARBON STEEL +ALUMINIUM +GLASS/NICKEL WIRE DRAWING



SM2362S-1
Φ120 x H110 (MAX H2000)

SM2362S-L1180
L1230 x W350 x H2000

SM2362S-R15
Φ635 x H2000

SM2362S-26RD
Φ660 x H3000



Like water droplets, no two Mizu are alike, each crystal shape is unique and made meticulously by hand. Using only the clearest crystal (24% lead), Mizu perfectly emulates water's refraction of light, casting amazing patterns around the room, reminiscent of flowing water.





ROYAL CHANDELIER
2359

MATERIAL ALUMINIUM + ACRYLIC GLASS
COLORS SUMMER BLACK/ SUMMER GOLD+ SAND GLASS





ROYAL CHANDELIER



SM2359-1100
Φ1150 x H3000



SM2359-1500
Φ1550 x H3000



SM2359-1750
Φ386xH3000

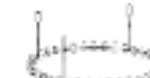

SM2359-2200
Φ2250 x H3000

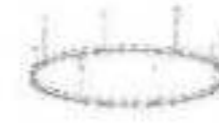

SM2359-3200
Φ3250 x H3000



SM2359S-4200
Φ4250 x H3000



SM2359S-R800-R1930
L1930 x W830 x H3000



SM2359S-L2000
L2030 x W32 x H2000



SM2359S-H3000
L161 X H3000

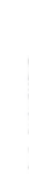

SM2359S-H2000
L161 X H2000



MULTI-LITE 2356

MATERIAL CARBON STEEL
COLORS BRUSHED BRASS+WHITE/SUMMER BLACK

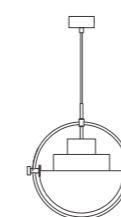

SM2356S
Ø386xH415 (MAX H1800)

MAUJETT-LITE





MACARON 2353

MATERIAL GLASS+ALUMINIUM+CARBON STEE+JADE
COLORS DRAWING COPPER+AMBER/SUMMER BLACK+SMOKEY GREY
DRAWING COPPER/SUMMER BLACK+CLEAR GLASS



SM2353T1
Ø300 x H255



SM2353T2
Ø400 x H360



SM2353T3
Ø540 x H475



MACARON





RAINEY 2341

MATERIAL CARBON STEEL
COLORS BRUSHED COPPER + EARL GOLD/ROSE GOLD/SUMMER BLACK



SM2341T
W145 (SHADE Φ 75) x H230



SM2341T2
W205X(SHADE Φ 200)xH300

RAINEY





ATOLLO METAL 2340

MATERIAL CARBON STEEL+ALUMINIUM ALLOY
COLORS BRUSHED COPPER+ LIGHT BLACK



SM2340T
Ø 250xH365



SM2340T2
Ø 380xH532



SM2340T3
Ø 500xH680



ATOLLO METAL





ATOLLO GLASS 621

MATERIAL CARBON STEEL+MILK ACID GLASS
COLORS MILKY WHITE



SM621T1
Ø 250xH350



SM621T2
Ø 370xH500





COPYCAT
2333

MATERIAL CARBON STEEL+ALUMINIUM ALLOY
COLORS EARL GOLD/ROSE GOLD/LIGHT BLACK+MILKY WHITE



SM2333T
W370 x H295(SHADE Ø 300)



Table lighting fixture comprising an aluminium sphere machined from solid and then gold-coated with 24 K gold. Blown glass opal diffuser. LED light source with dimmer switch on the power cable.





AELLA
2332

MATERIAL
COLORS

ALUMINIUM ALLOY+GLASS
BRUSHED COPPER+CLEAR GLASS/SUMMER BLACK+SMOKEY GREY





AELLA



SM2332T1
Φ200 x H 280



SM2332T2
Φ300 x H 280



SM2332T3
Φ540 x H 500



SM2332S1
Φ200 x H 2000



SM2332S2
Φ300 x H 2000



SM2332S3
Φ540 x H 2000



SM2332C1
Φ200 x H 170



SM2332C2
Φ300 x H 190



SM2332C3
Φ540 x H 310



GLEN
2324

MATERIAL
COLORS

CARBON STEEL + GLASS
BODY SUMMER BLACK + SMOKE GRAY / AMBER / ROSE GOLD / COFFEE





Hand-blown glass, the color is crystal clear, makes the light beam wider and softer.

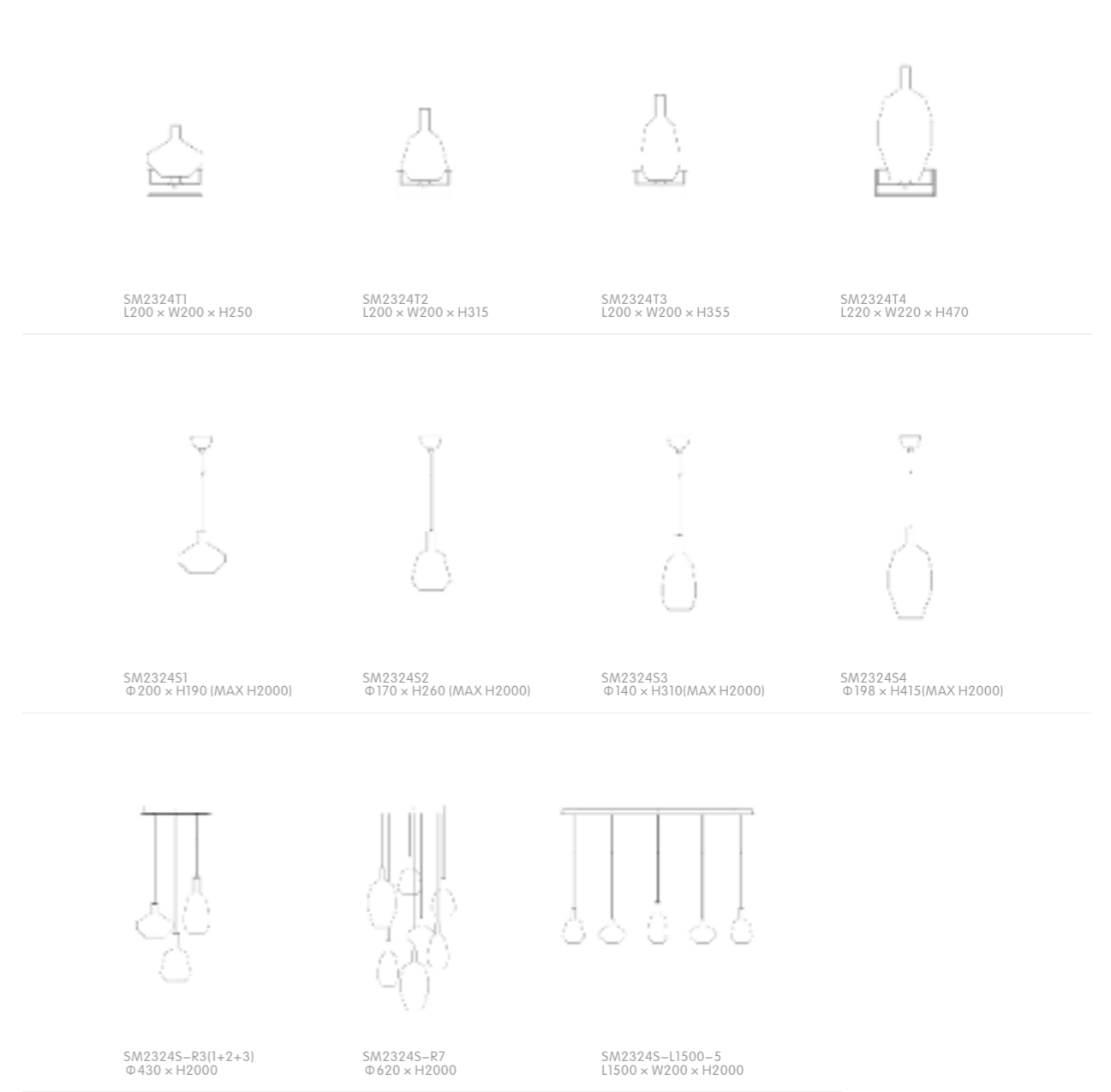

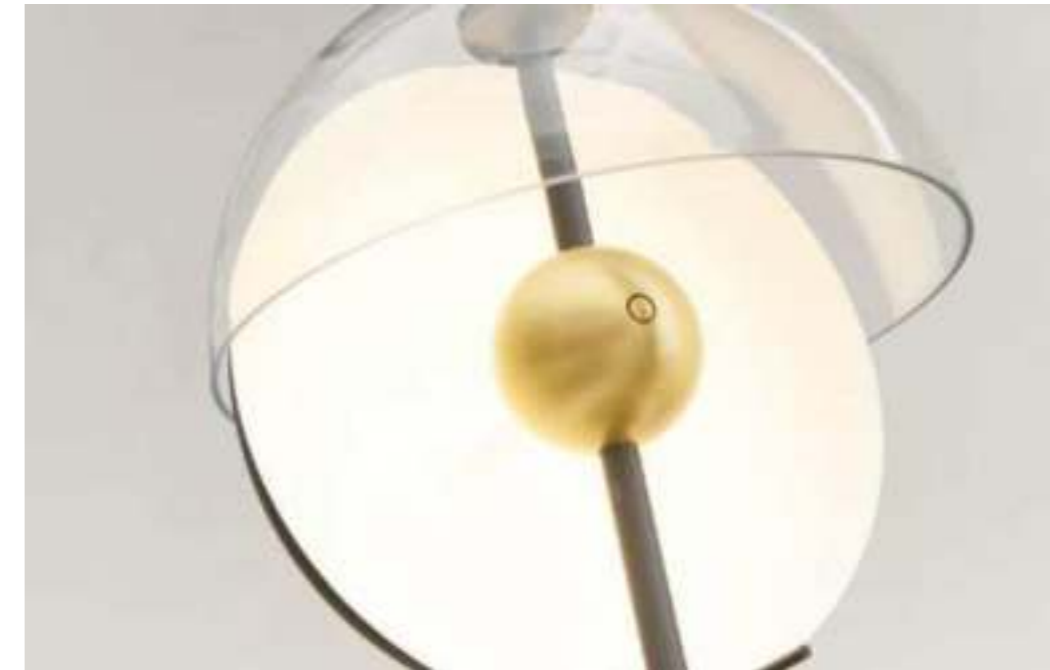

THEIA 2322

MATERIAL CARBON STEEL/ALUMINUM ALLOY/GLASS
COLORS SEMI-MATTE WHITE/CROWN ASH CLEAR/SOOT/AMBER



SM2322T
Φ 320 × H 470



SM2322F
Φ 320 × H 1530







VL RING CROWN 2321

MATERIAL CARBON STEEL/YOGURT GLASS
COLORS SILVERY/CREAMY WHITE



SM2321S-1
Φ190 × H350(MAX H2000)



SM2321S-R3
Φ560 × H240(MAX H2000)



SM2321S-R5
Φ680 × H240(MAX H2000)



SM2321S-R7
Φ880 × H240(MAX H2000)



SM2321W
Φ190 × W240 × H280



VL RING CROWN



IC LIGHTS 2318

MATERIAL CARBON STEEL+GLASS+ALLUMINIUM
COLORS SUMMER GOLD/SUMMER BLACK



By Michael Anastassiades, 2014

Table lamp providing diffused light. Frame in brass,
brushed and transparent varnished or chrome steel.

Blown glass opal diffuser. Dimmer on the power chord.





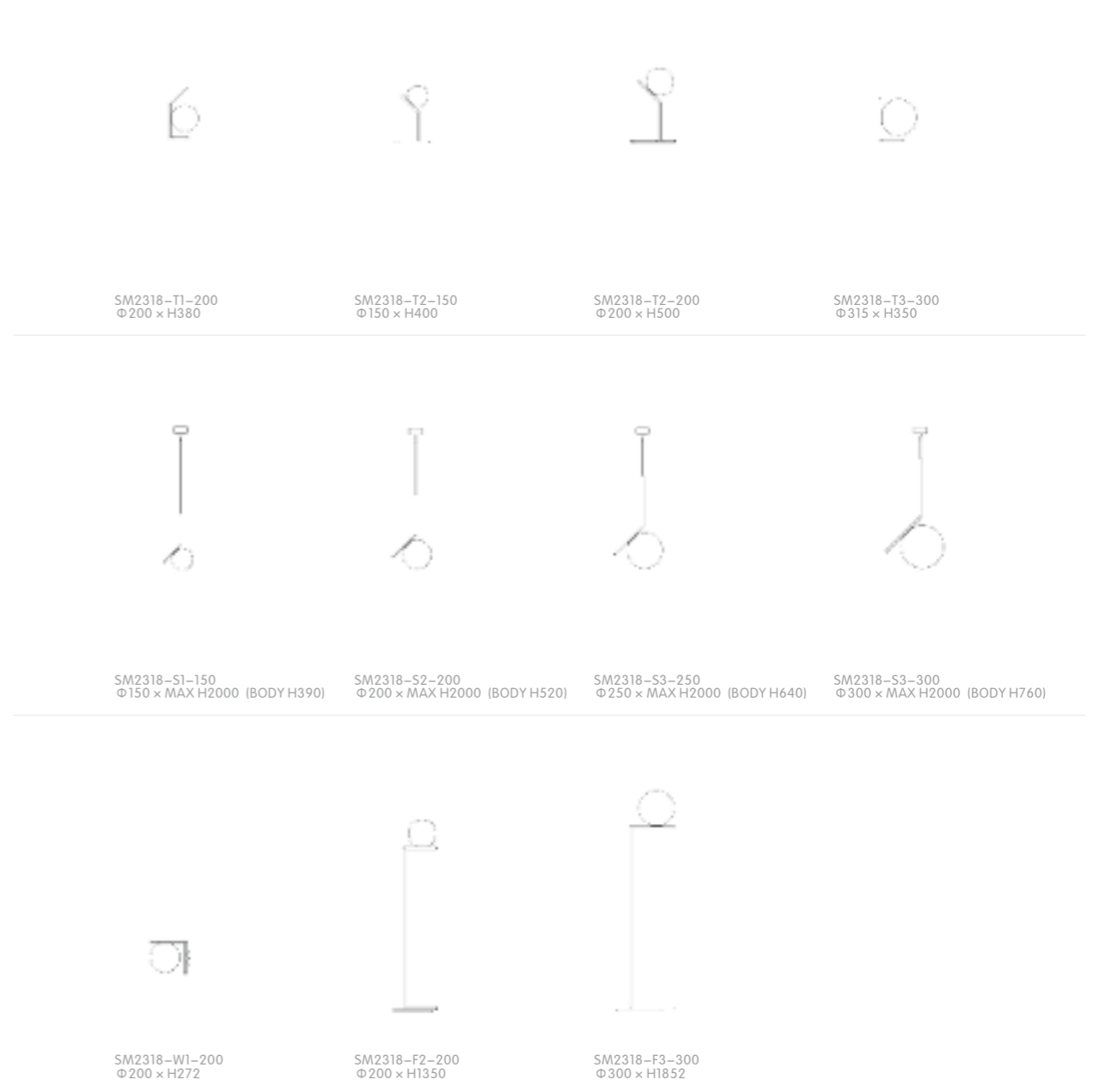

IC LIGHTS



LIGHT RING 2316

MATERIAL ALUMINIUM ALLOY+PC
COLORS SUMMER UNION GOLD / MATTE BLACK



SM2316S1
Φ 600 x H2000



SM2316S2
Φ 900 x H2000



SM2316S3
Φ 1200 x H2000

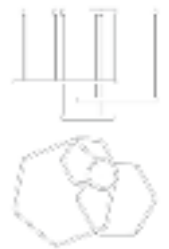

2316S-R3(S1+S2+S3)
L1220(I1400) x W1600(I1800) x H2000



LIGHT RING

-





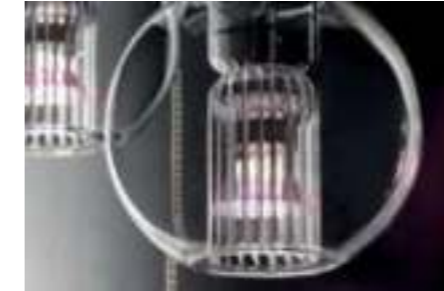
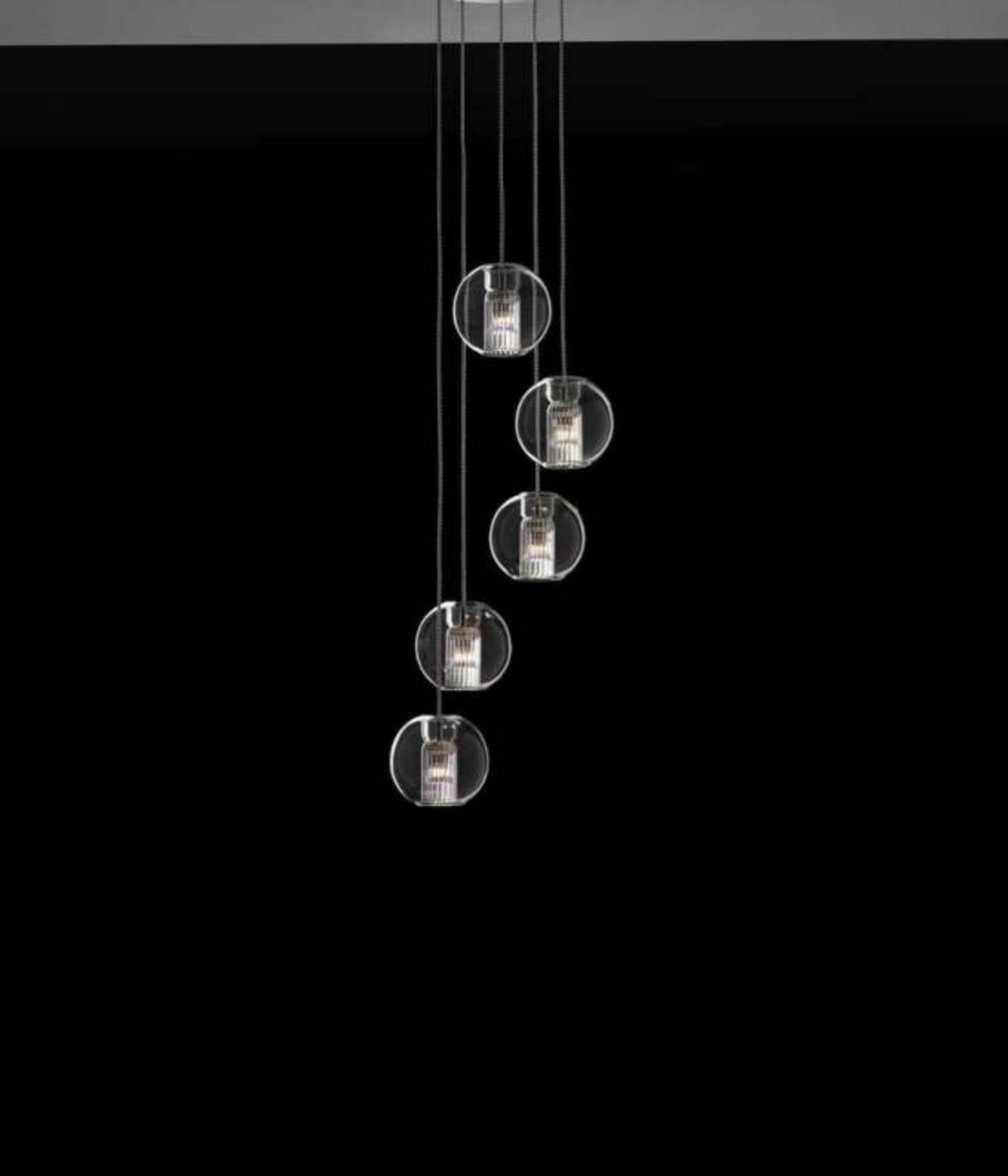

FAIRY 2307

MATERIAL
COLORS

CARBON STEEL + ALUMINIUM
BLACK / BRUSHED COPPER



SM2307DZ
Ø140



SM2307DZ
Ø180



SM2307S1 -1
Ø140 x H196 (MAX H2000)



SM2307S2 -1
Ø180 x H150 (MAX H2000)



SM2307S(1+2)-26
Ø 900 x H3000



SM2307S6DJ

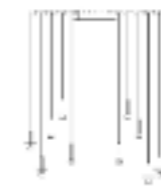

SM2307S12DJ

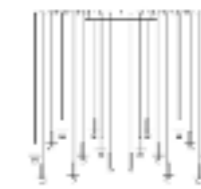

SM2307S18DJ



SM2307S24DJ



FAIRY



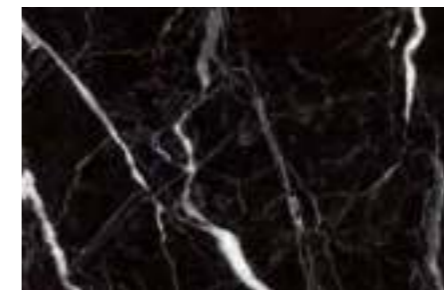

GOSS
2306

MATERIAL
COLORS

CARTON STEEL+GLASS
GOLD/CHROME



SM2306T-A
Ø 280 x H260





COSS



MOUNTAIN VIEW 2305

MATERIAL
COLORS

CARTON STEEL+GLASS
GOLD/CHROME



SM2305S1
Ø 400 x SHADE H310 (MAX H2000)



YURI



YURI
2303

MATERIAL
COLORS

CARBON STEEL+MILK ACID GLASS
EARL GOLD+MILKY WHITE





SM2303T1
Φ 245 × W200 × H335



SM2303T2
Φ 327 × W300 × H480



SM2303W1
Φ 264 × W200 × H283



SM2303C
Φ 425 × W300 × H385



SM2303S1
L230 × W200 × H2000 (SHADE H310)



SM2303S2
L330 × W300 × H2000 (SHADE H455)



JOSH
2302

MATERIAL
COLORS

CARBON STEEL+ALUMINIUM ALLOY
BRUSHED COPPER+MILKY WHITE/EARL MILKY WHITE



SM2302T
Φ 230 x H350



SM2302T2
Φ 320 x H470

JOSH

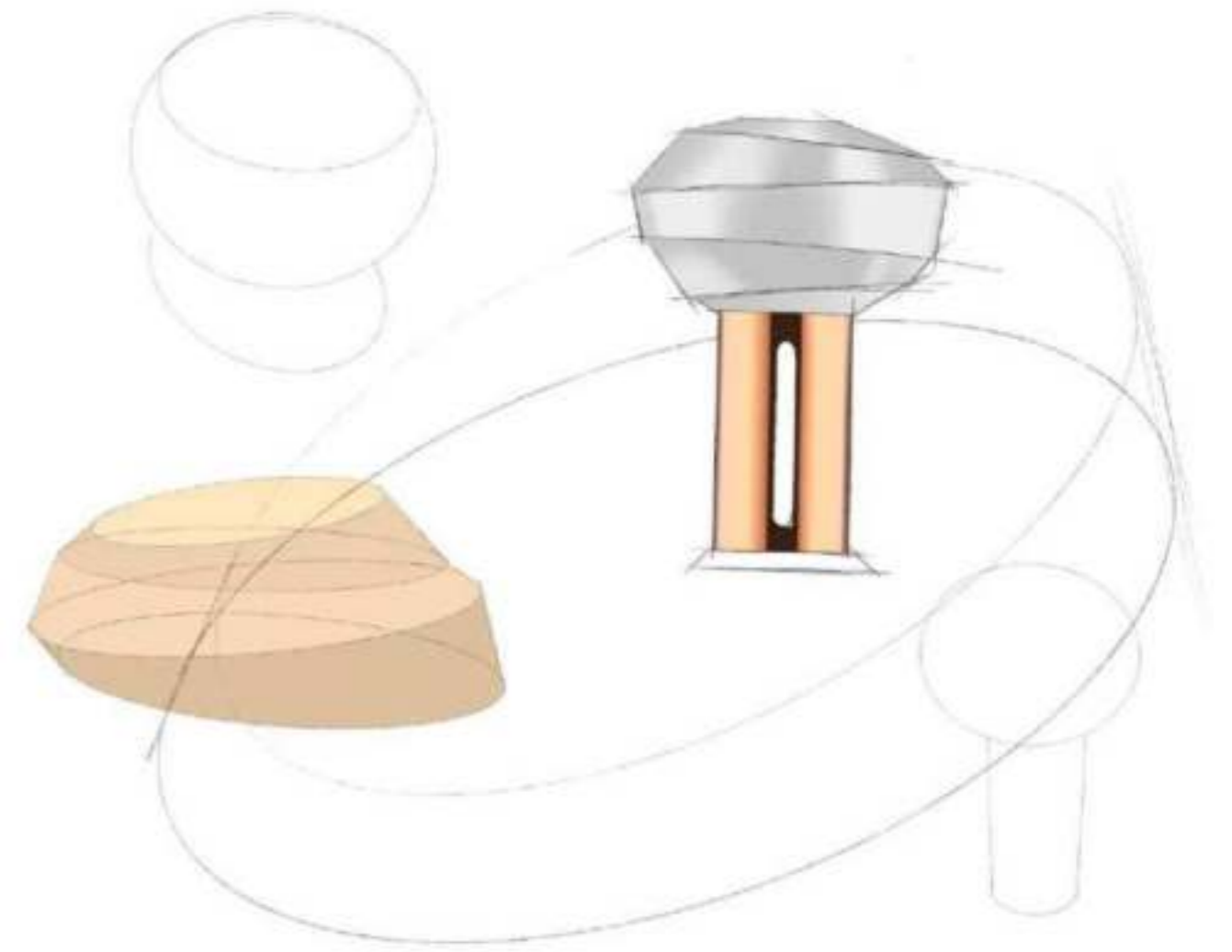



HUNTER 2301

MATERIAL
COLORS

CARBON STEEL+GLASS
MATT WHITE+CLEAR GLASS/SMOKEY GREY/AMBER/ROSE GOLD



SM2301T1-A
Φ130 x H280



SM2301T2-A
Φ180 x H345



SM2301T3-A
Φ250 x H450



SM2301W1
L280 x W172 x H280



SM2301S1-A
Φ130 x BODY H260 (MAX H2000)



SM2301S2-A
Φ180 x BODY H320 (MAX H2000)



SM2301S3-A
Φ250 x BODY H425 (MAX H2000)



SM2301S4-A
Φ300 x BODY H500 (MAX H2000)



SM2301S-R7
Φ610 x H2000

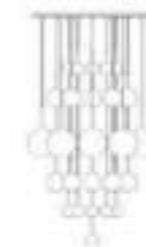

SM2301S-R1150
Φ1500 x H2800



SM2301S-R41
Φ1650 x H3000





FINN
2300

MATERIAL ALUMINIUM ALLOY+PC
COLORS BLACK/WHITE/SUMMER GOLD



SM2300F
L127 x W102 x H1853

FINN

—



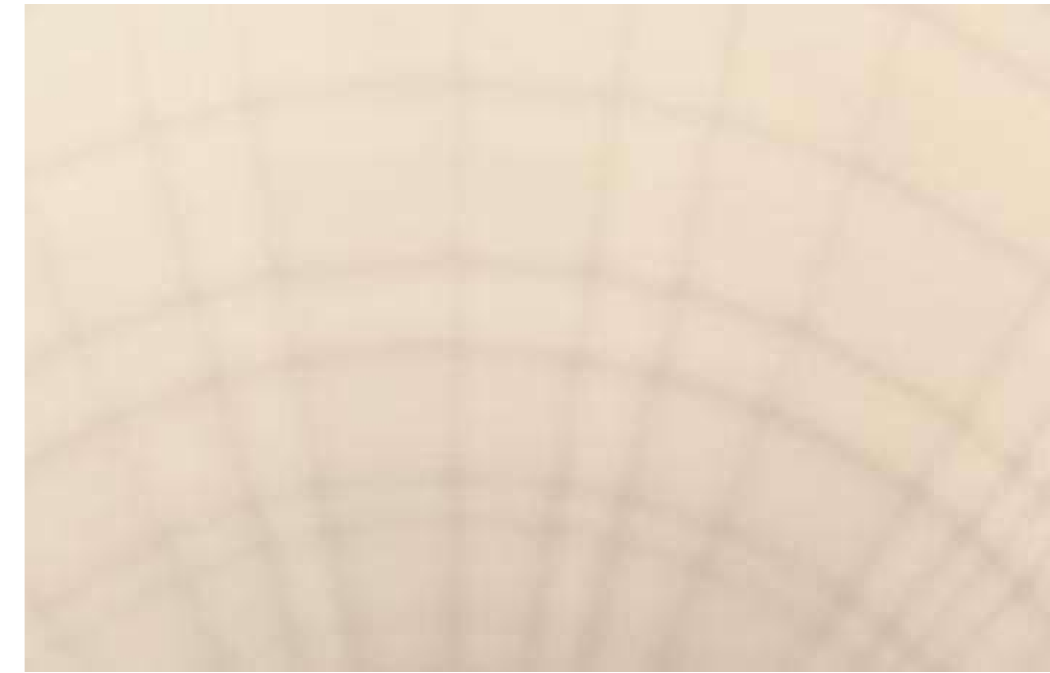

ALBA
2294

MATERIAL
COLORS

CARBON STEEL+MILK ACID GLASS
TI-PURPLE GOLD/SHALLOW TITANIUM BASE+MILKY WHITE





SM2294T1-1
Φ260 × H220



SM2294T2-1
Φ350 × H280



SM2294T1-2
Φ260 × H410



SM2294W1
L265 × W260 × H240



SM2294F1-1
L450 × W260 × H1610



SM2294S1
Φ260 × H2000



SM2294S2
Φ350 × H2000





TRIGONA 2292

MATERIAL ALUMINIUM + GLASS
COLORS SUMMER BLACK + WHITE GRADIENT OUTER GLASS +
SMOKY GREY MIDDLE GLASS+ WHITE INNER GLASS



SM2292S
Ø 305 x H 540



TRIGONA
-

OTTO

-





OTTO
2290

MATERIAL
COLORS

CARTON STEEL+GLASS
BRUSH GOLD(PLATING)



SM2290S1
Φ 260 x MAX H2000



SM2290S2
Φ 400 x MAX H2000

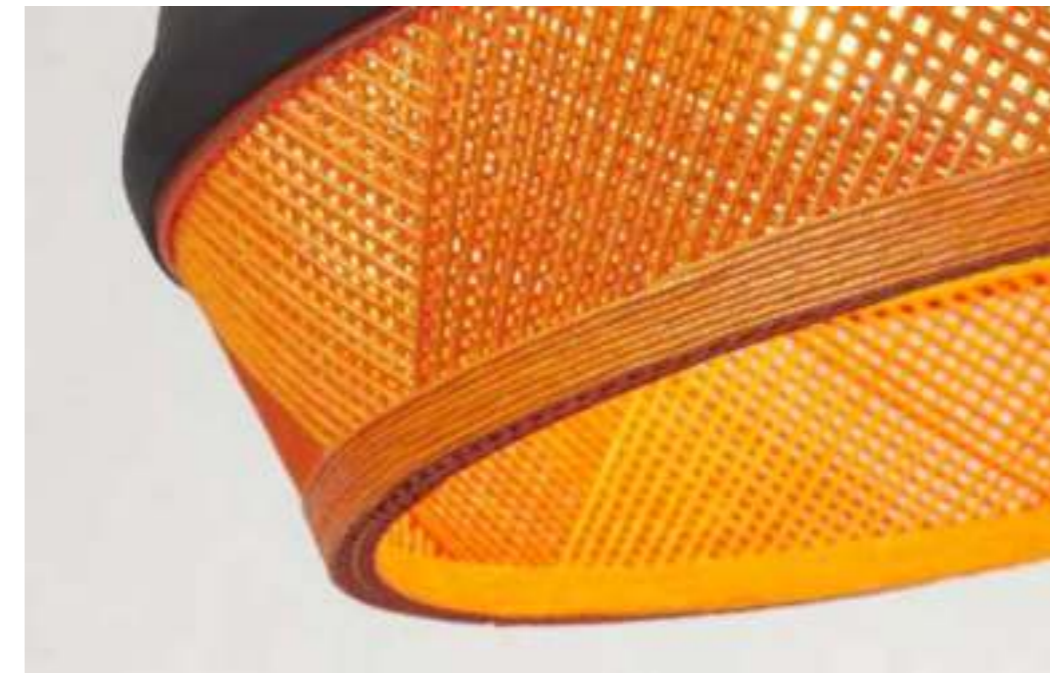

ACKERY 2289

MATERIAL CARBONSTEEL+RATTAN+ALUMINIUM
COLORS UPPER BLACK UMDER WHITE/BLACK+ORANGE/WHITE+ORANGE/
UPPER BRUSH COPPER UMDER ORANGE



SM2289T-A
Φ355 x H560



SM2289F-A
Φ555 x H1700



SM2289S1-A
Φ355 x H2000



SM2289S2-A
Φ555 x H2000



ACKERY





BABER 2282

MATERIAL
COLORS

GLASS+ALUMINIUM
CLEAR+ROSE GOLD / CLEAR/SMOKEY GREY+SUMMER BLACK

BABER



SM2282C
Φ255 x H95



SM2282S
Φ255 x BODY H95(MAX H2000)

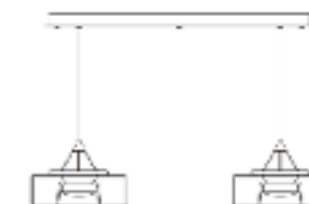

SM2282S-2
L990 x W255 x H2000





ODA 2275

MATERIAL
COLORS

CARBON STEEL+GLASS
AMBER/SMOKEY GREY/CLEAR GLASS+BLACK



SM2275T1
Φ225 x H430(body H290)



SM2275T2
Φ420 x H845(body H580)



SM2275F2
Φ420 x H1416(body H1150)



SM2275F2-1650
Φ480 x H1650(shade Φ420)





NUVOLA MINOR 2269

MATERIAL PLASTIC+CARBON STEEL +PC
COLORS WHITE



SM2269SX
L800 x W290 x H2000

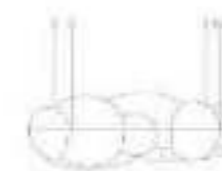

SM2269S
L1500 x W900 x H2000

NUOVA OLAMINOR



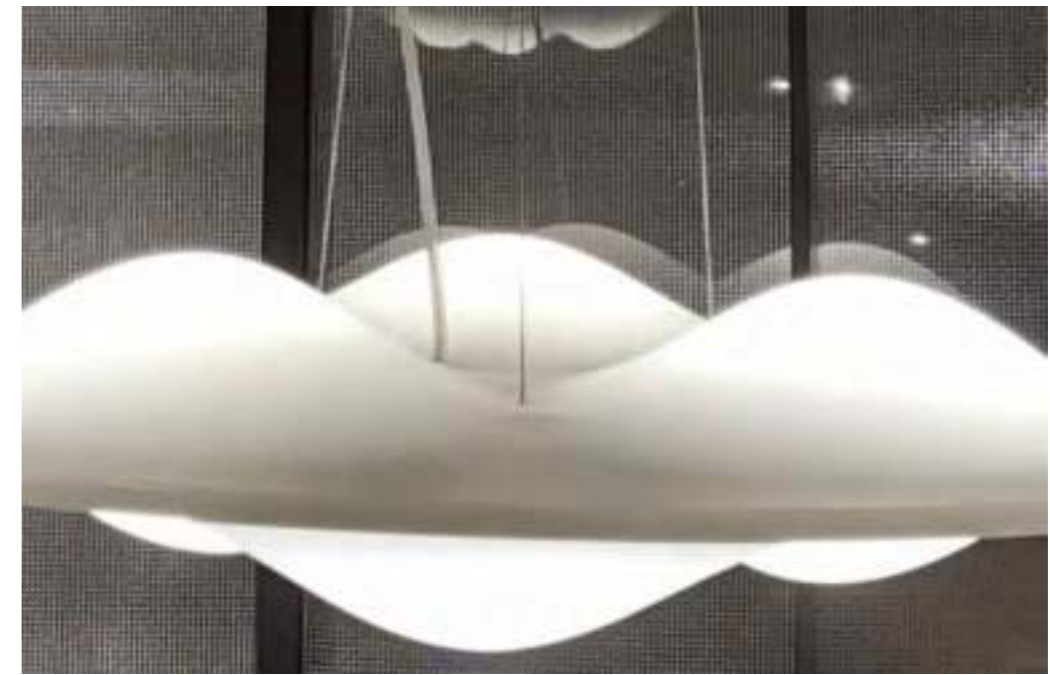

THE HILLS 2263

MATERIAL
COLORS

ALUMINIUM ALLOY+ACRYLIC
WHITE



SM2263C1
Ø 500 x H135



SM2263C2
Ø 650 x H170



SM2263C3
Ø 850 x H195



SM2263S1
Ø 500 x H2000



SM2263S2
Ø 650 x H2000



SM2263S3
Ø 850 x H2000



CHESHIRE MEDIUM 2259

MATERIAL PC+ALUMINIUM ALLOY+CARBON STEEL +PLASTIC
COLORS SHINING WHITE/BLACK+EARL GOLD+CHROME



SM2259T
Φ300 × H505



SM2259F
Φ300 × H1500

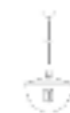

SM2259S
Φ300 × H 2000





AIM
2253

MATERIAL
COLORS

ALUMINIUM ALLOY
MATT BLACK INSIDE WHITE/ WHITE



SM2253S
Φ245 x H2000



SM2253S1
Φ170 x H1460

AIM





AIM



PINECONE
2245

MATERIAL CARBON STEEL+PLASTIC +PC
COLORS WHITE





SM2245W1
L410 x W205 x H315



SM2245S1
Φ410 x H2000 (BODY H315)



SM2245S2
Φ670 x H2000(BODY H502)



SM2245T1-B
Φ410 x H560 (BODY H315)



SM2245F1-A
Φ410 x H1730



SM2245F2
Φ670 x H1800





TATOU 2243

MATERIAL PC+CARBON STEE
 COLORS WHOLE MATT WHITE/ VIOLET SHADE+MATT BLACK BODY



SM2243T1
 Φ278 x H450



SM2243T2
 Φ400 x H640



SM2243F1
 Φ278 x H1300



SM2243F2
 Φ400 x H1660



SM2243S1
 Φ278 x H2000



SSM2243S1
 Φ400 x H2000





HONEYCOMB 2242

MATERIAL ABS+ ALUMINIUM ALLOY L:910 W:325
COLORS WHITE



SM2242S9-L600
L600 x W435 x H230

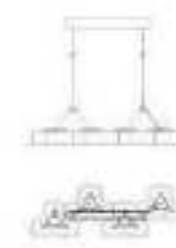

SM2242S12-L910
L910 x W325 x H230

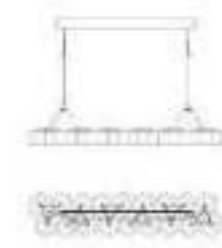

SM2242S18-L1170
L1170 x W275 x H230



SM2242C9-L490
L490 x W420 x H130



SM2242C18-L700
L700 x W525 x H130



SM2242C24-L980
L980 x W625 x H130

HONEYCOMB



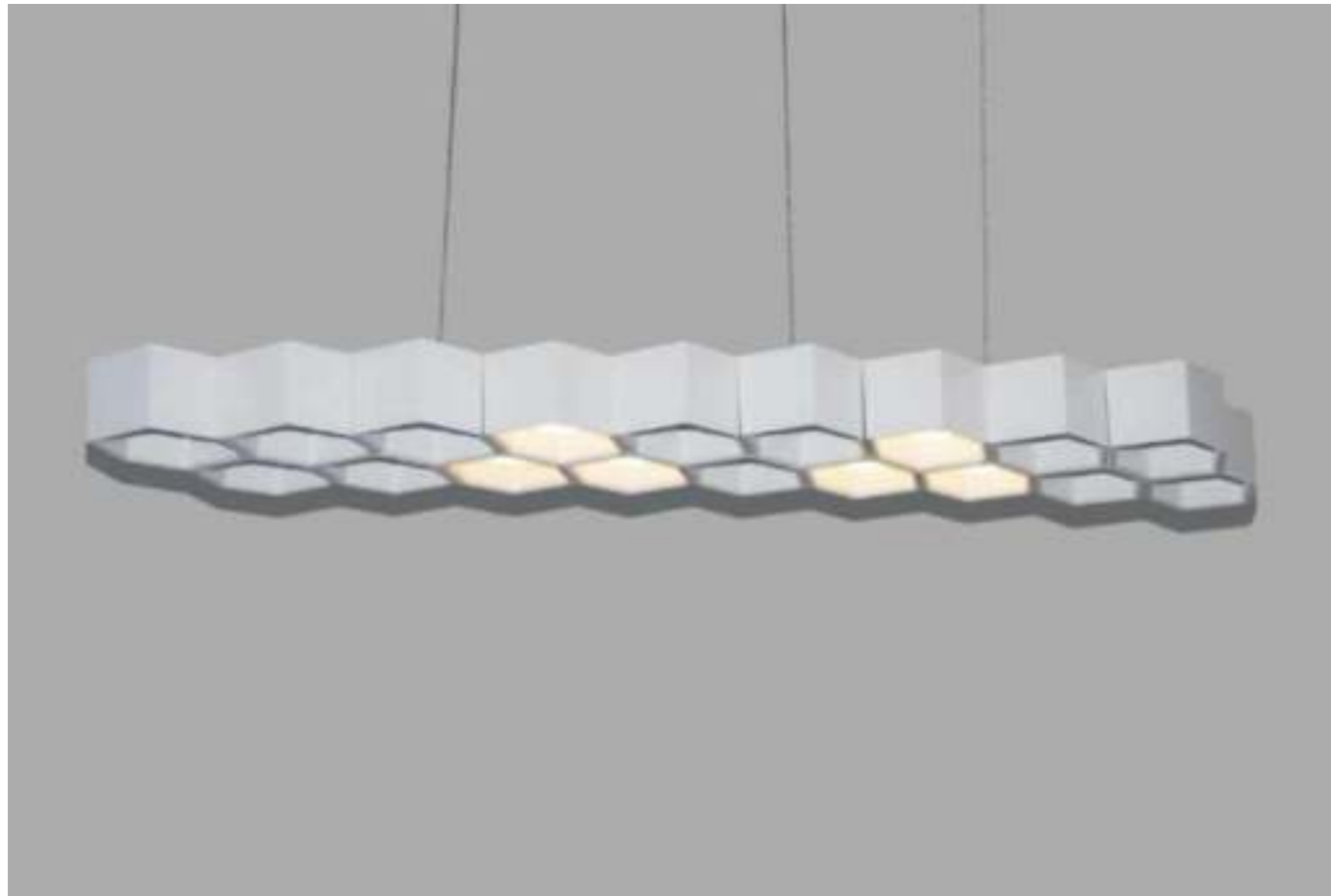



LOGIGO
2236

MATERIAL
COLORS

GLASS/ CARBON STEEL
WHITE









SM2236T1
Φ165 x H345



SM2236T2
Φ213 x H440



SM2236T3
Φ286 x H645



SM2236F2
Φ286 x H1490



SM2236F3
Φ355 x H1735



SM2236S1-1
Φ180 x H170 (MAX H2000)



SM2236S2-1
Φ280 x H230 (MAX H2000)



SM2236S3-1
Φ400 x H310 (MAX H2000)



SM2236S1-R6
Φ800 x H190 (MAX H2000)



SM2236S1-R8
Φ585 x H190 (MAX H2000)



SM2236S2-R6
Φ800 x H240 MAX 2000



SM2236S2-R8
Φ1000 x H240 (MAX H20000)



SM2236C1-R8
Φ1200 x H2000



SM2236C2-R3
Φ625 x H 265



SM2236C2-R6
Φ800 x H 265



SM2236C2-R8
Φ1000 x H MAX2000



CHOU CHIN 2230

MATERIAL GLASS/CARBON STEEL/ALUMINIU
COLORS IVORY/ORANGE/GREEN



SM2230S1
Φ220 x H2000



SM2230S2
Φ300 x H2000



SM2230S3
Φ400 x H2000



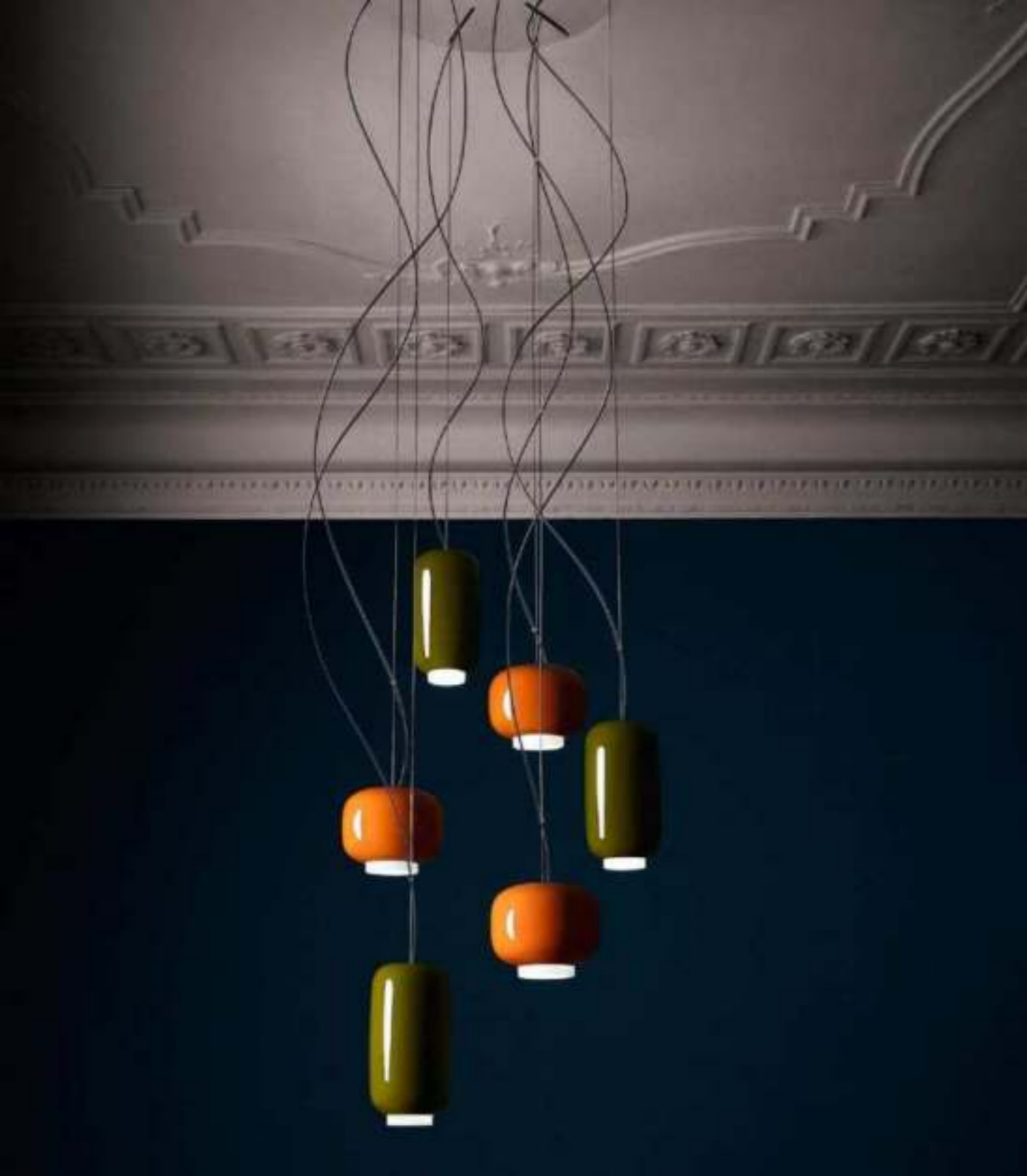

CHOU CHIN





BUDS 2229

MATERIAL
COLORS

ALUMINIUM ALLOY/ GLASS
GOLD OXIDE+SMOKEY GREY/GOLD OXIDE+CLEAR GLASS/SUMMER BLACK+SMOKEY GREY



SM2229T
Φ227 × H390



SM2229S
Φ230 × H360 (2000)

BUDS





PUBINO



PUBINO 2227

MATERIAL ALUMINIUM ALLOY
COLORS SHINNING BLACK/ SHINNING WHITE/RED



SM2227F
Φ550 × H1830



SM2227S
Φ180 × H2000

PUBINO





EVIE

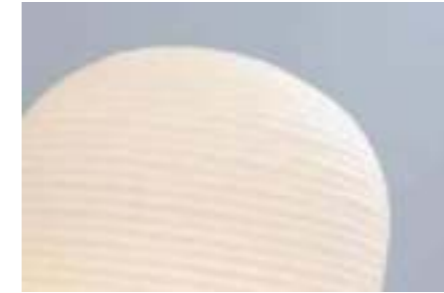

EVIE 2223

MATERIAL CARBON STEEL GLASS
COLORS DARK GREY



SM2223T1
Φ200 x H265



SM2223T2
Φ240 x H390



SM2223T3
Φ340 x H270



SM2223S1
Φ200 x H2000



SM2223S2
Φ240 x H2000



SM2223S3
Φ340 x H2000





EVIE



MUFFINS 2221

MATERIAL MARBLE+CARBON STEEL +GLASS
COLORS JAZZ WHITE+AMBER/SMOKEY GREY/CLEAR GLASS
BLACK AND WHITE ROOT+AMBER/SMOKEY GREY/CLEAR GLASS



SM2221T1-A
Ø 370 x H345



SM2221T2-A
Ø 530 x H505



SM2221T3-A
Ø 435 x H1020







REEDER 2211

MATERIAL
COLORS

FABRIC / CARBON STEEL
GOLD DRAWING



SM2211T
Ø 350 x H665



SM2211F
Ø 520 x H1725



The combination of light and thin cloth art makes the light diffuse in the air, dazzling brilliance under the refraction of light, comfortable transmission of light, and soft light,





SCOPAS 2210

MATERIAL ALUMINIUM ALLOY/ PC
COLORS ROSE GOLD /EARL GOLD/BLACK



SM2210S
Ø500 x H2000





CROWN MAJOR CHANDELIER 2209

MATERIAL ZINC ALLOY+CARBON STEEL+GLASS
COLORS WHITE/DARK GREY/CHROME/SATIN NICKEL/EARL GOLD



SM2209S1-R6
Φ790 × H2000



SM2209S1
Φ790 × H2000



SM2209S2
Φ1200 × H2500



The Crown is a modern reinterpretation of the traditional candle chandeliers. You can selected matt white, matt black, painted gold or polished aluminium.





Crown Major suspension light comes with a transparent cable, 2 meters long, but a red cable can be available on request.

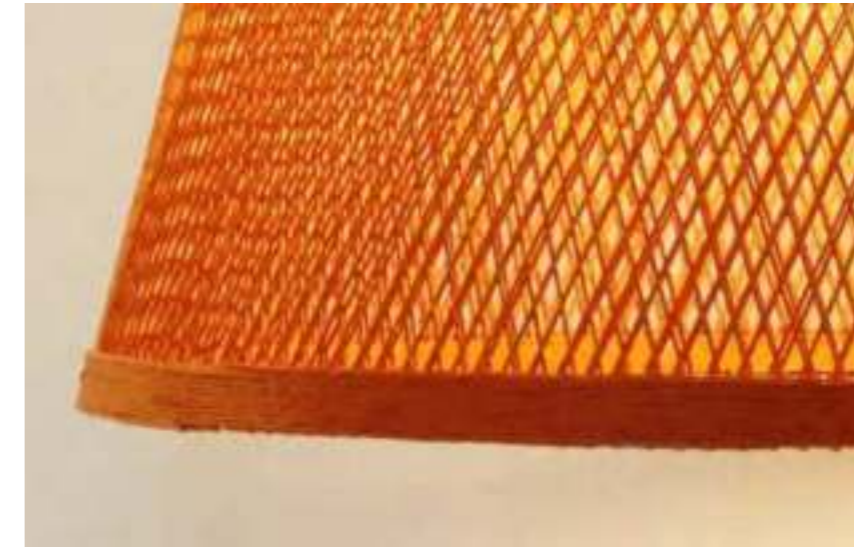

WIND 2158

MATERIAL ALUMINIUM+ PMMA+FIBER /PMMA
 COLORS ORANGE/WHITE/BLACK/GREEN



SM2158T2
 Ø 380 x H675



SM2158F1
 Ø 600 x H1730



SM2158F2
 Ø 600 x H1900



SM2158S1
 Ø 600 x H310(MAX H2000)



SM2158S2
 Ø 600 x H480(MAX H2000)



WIND

Using a novel rattan twist, this chandelier combines technology and tradition

The Wind series comes in a variety of finishes: white, black, green and orange.





GIANT 2155

MATERIAL
COLORS

ALUMINIUM+CARBON TEEL
WHITE/BLACK /RED



SM2155T
L405 x W150 x H750



SM2155F
L1150 x W440 x H2070

GIANT

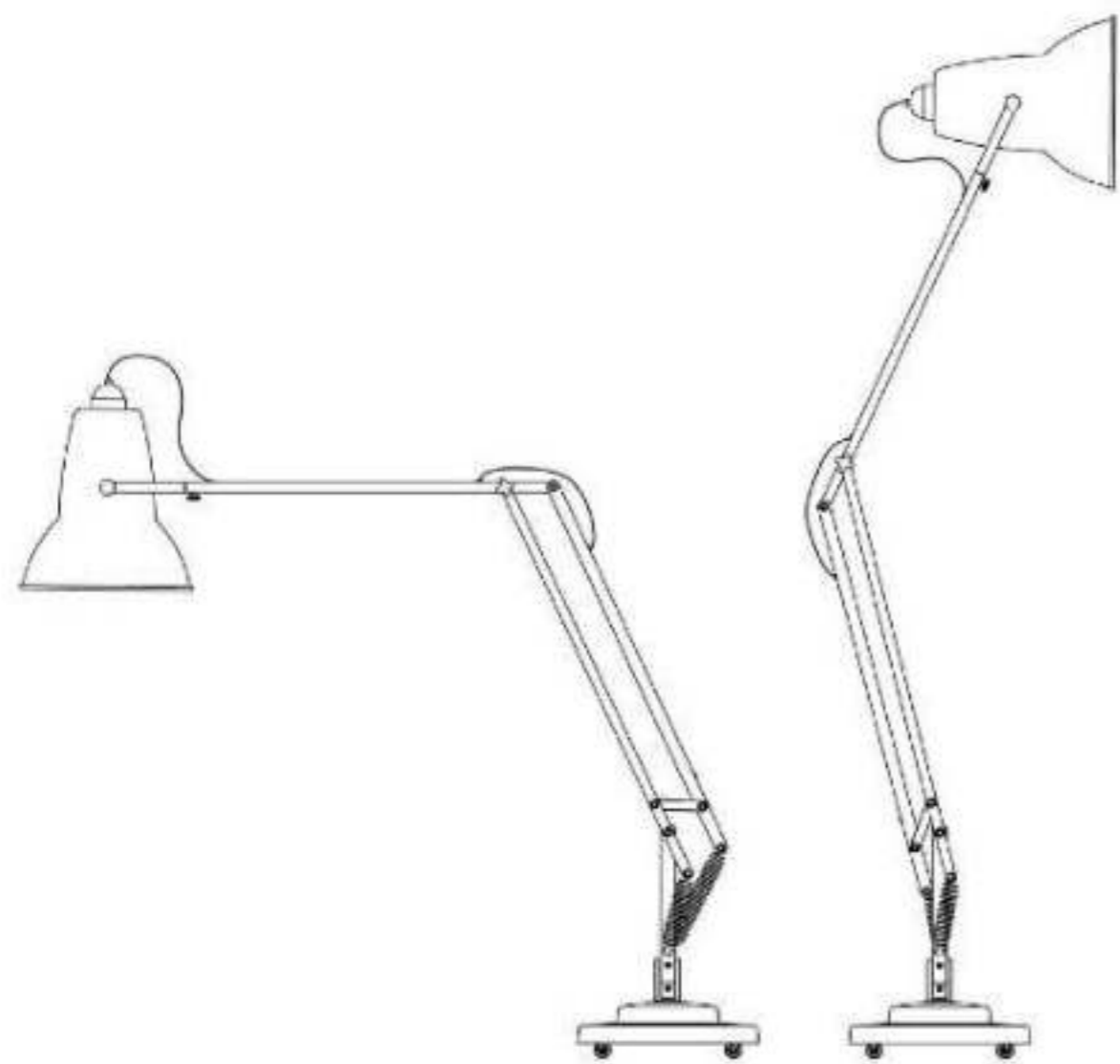





ARNE JACODSEN
2152

MATERIAL
COLORS

CARBON STEEL+ALUMINIUM ALLOY
MATT BLACK/MATT WHITE/CREAM GREY/LIGHT BLUE



SM2152T
Φ330 x H550



SM2152F
Φ330 x H1330







TORNADOES 2124

MATERIAL	PC+CARBON STEEL
COLORS	WHITE



SM2124S1
Ø 860 x H700 (MAX H2800)



SM2124S2
Ø 1080 x H1160 (MAX H2800)

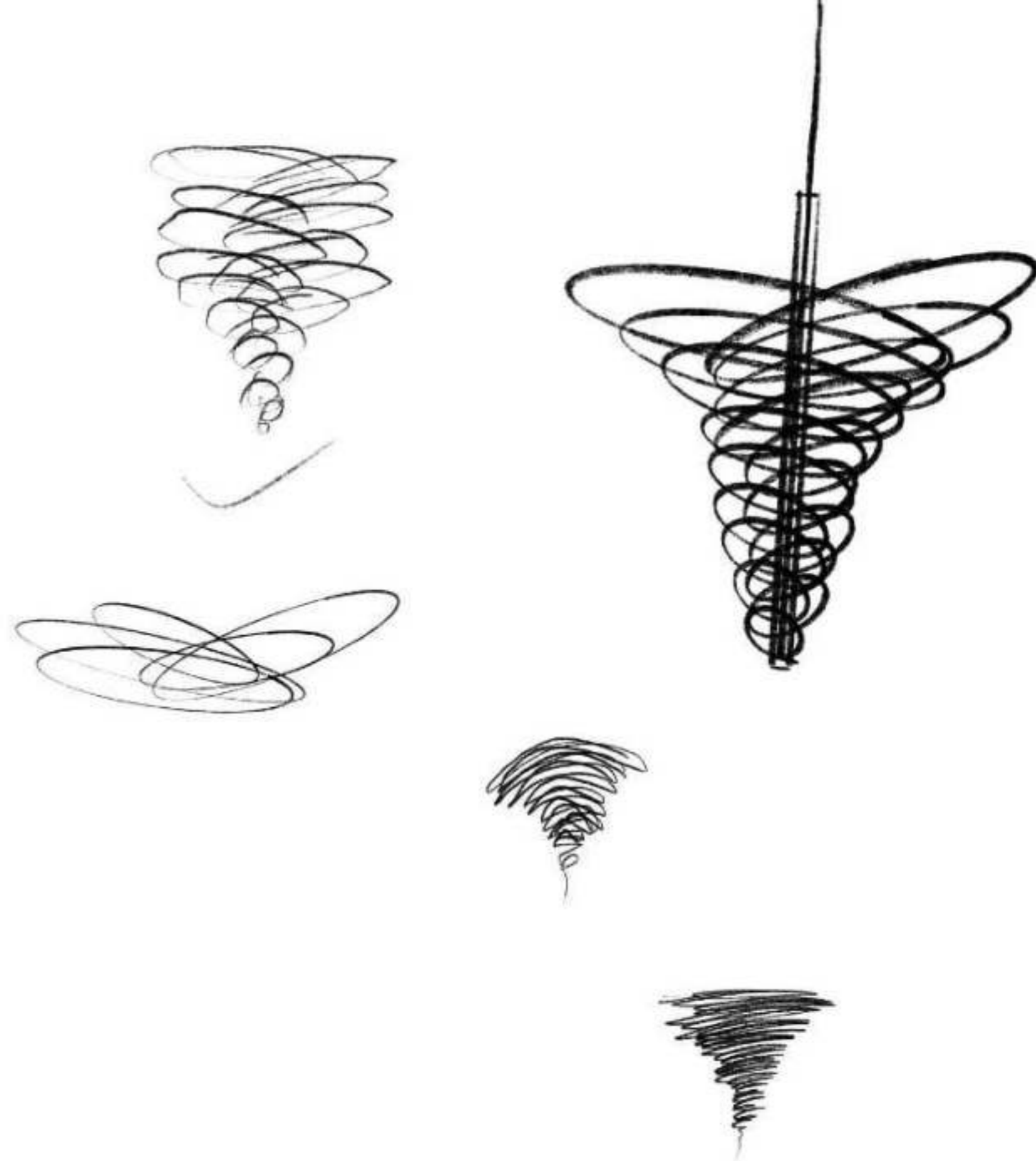



I.CONO 2112

MATERIAL
COLORS

ABS+ZINC ALLOY
WHITE/BLACK/ORANGE



SM2112T
L235 x W215 x H620



SM2112FA
L300 x W395 x H1350





MOON



MOON 2111

MATERIAL CARBON STEEL
COLORS WHITE/ORANGE/BRUSH GOLD(PLATING)



SM2111S1
Φ:345 x H1900



SM2111S2
Φ:425 x H2000

MOON

The iconic pendant is characterized by its fan-like design with ten ring-shaped aluminum lamellae positioned to provide a soft, ambient, and glare-free light. The blades reflect and filter the light and the pendant changes its appearance depending on the angle at which you view it.





LUMEN 2105

MATERIAL ALUMINIUM/ZINC ALLOY
COLORS CHROME



SM2105T
Ø750 x H690



SM2105F
Ø750 x H1600



READER

1119

MATERIAL
COLORS

FIBERGLASS
WHITE



1119F
L640 x W700 x H720



DESIGN



ASSAI
966

MATERIAL
COLORS

CARBON STEEL
DARK GREY/BROWN/CHAMPAGNE GOLD

ASSAI





SM966S1
Φ 510 x H615 (MAX H2800)



SM966S2
Φ 760 x H870 (MAX H2800)



SM966S3
Φ 750 x H810 (MAX H2800)



MARTINE LLI LUCE

MARTINELLI LUCE 965

MATERIAL
COLORS

PC
BLACK/WHITE/ORANG



965T
Ø 420 x H390

MARTINELLI LUCE







PIRCE
962

MATERIAL ALUMINIUM
COLORS WHITE



962S
L970 x W940 x H280(MAX H2000)



962MINI
L690 x W670 x H280(MAX H2000)

PIRCE





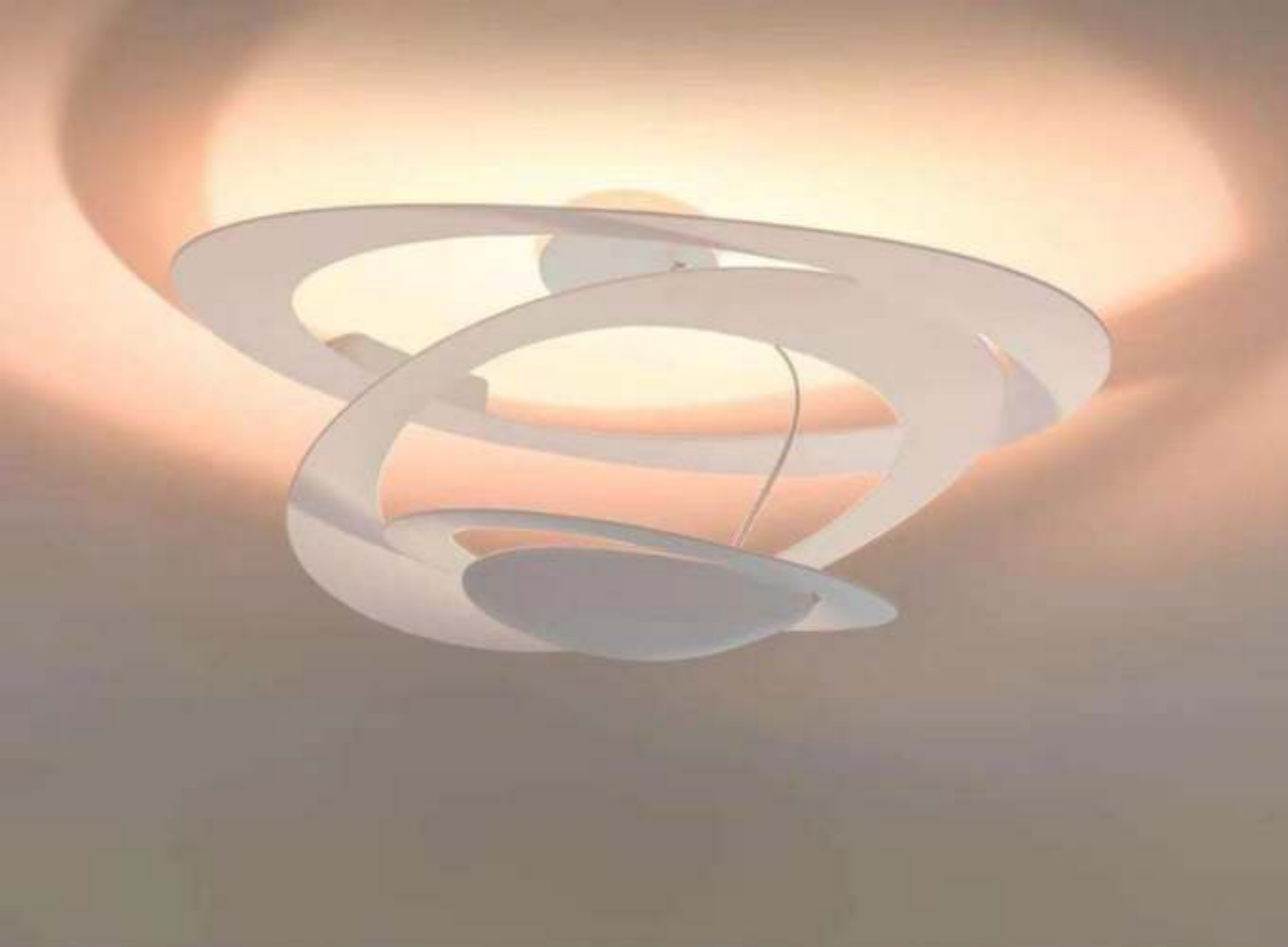

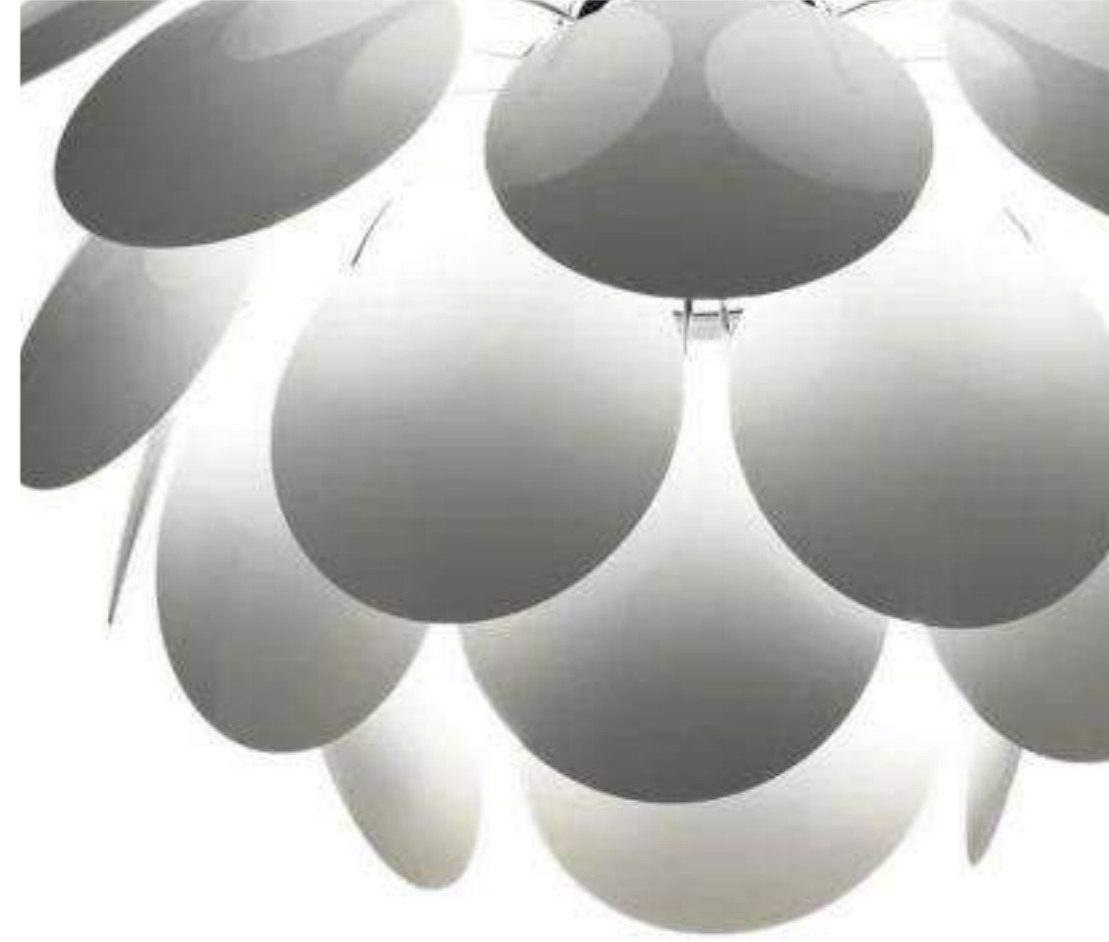

DISCOCO
961

MATERIAL ABS CARBON STEEL ABS
COLORS RED/BLUE



961S1
Ø 530 x MAX H 2000







ARA
939

MATERIAL
COLORS

CARBON STEEL
CHROME/LIGHT BLUE/SILK GREY/BEIGE RED



939T-LED
Ø 350 x H570

ARA





HOPE
925

MATERIAL CARBON STEEL / PC
COLORS BLACK BODY



HOPE







SM925S1
Φ:500 × MAXH:2000



SM925S2
Φ:600 × MAXH:2000



SM925S3
Φ:800 × MAXH:2000



SM925S4
Φ:1000 × MAXH:2000



SM925W
L600 × W580 × H460



SM925C
Φ:700 × H470



SM925S5-3
Φ:1800 × MAXH:4500



SM925T
Φ:520 × H820



SM925F2
Φ:700 × H1680



SM925F3
Φ:800 × H2000



ZOEY 913

MATERIAL GLASS/CARBON STEEL
COLORS WHIT



913T1
Φ 200 x H325



913T2
Φ 380 x H510



913F2
Φ 380 x H1720



ZOEY





NEBULA 909

MATERIAL
COLORS

GLASS/CARBON STEEL
WHITE



90951
Ø 500 x H:800



NEBULA

—



PEARL 907

MATERIAL
COLORS

FABRIC/CARBON STEEL
BRUSHED COPPER+MATT BLACK+BEIGE/SATIN NICKEL+MATT BLACK+BEIGE

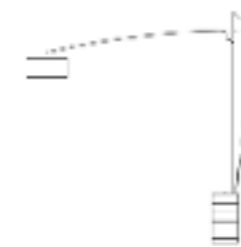

SM907F
L2400 x W500(SHADE) x H2200



PEARL





TARAXACUM 903

MATERIAL STAINLESS STEEL
COLORS BRUSHED COPPER+CHROME BODY



SM903S
Ø 800 x H800





JJ GREAT 902

MATERIAL ALUMINIUM/CARBON STEEL
COLORS BLACK/WHITE



SM902F1
L2035 x W600 x H1800



SM902F2
L1780 x H2330



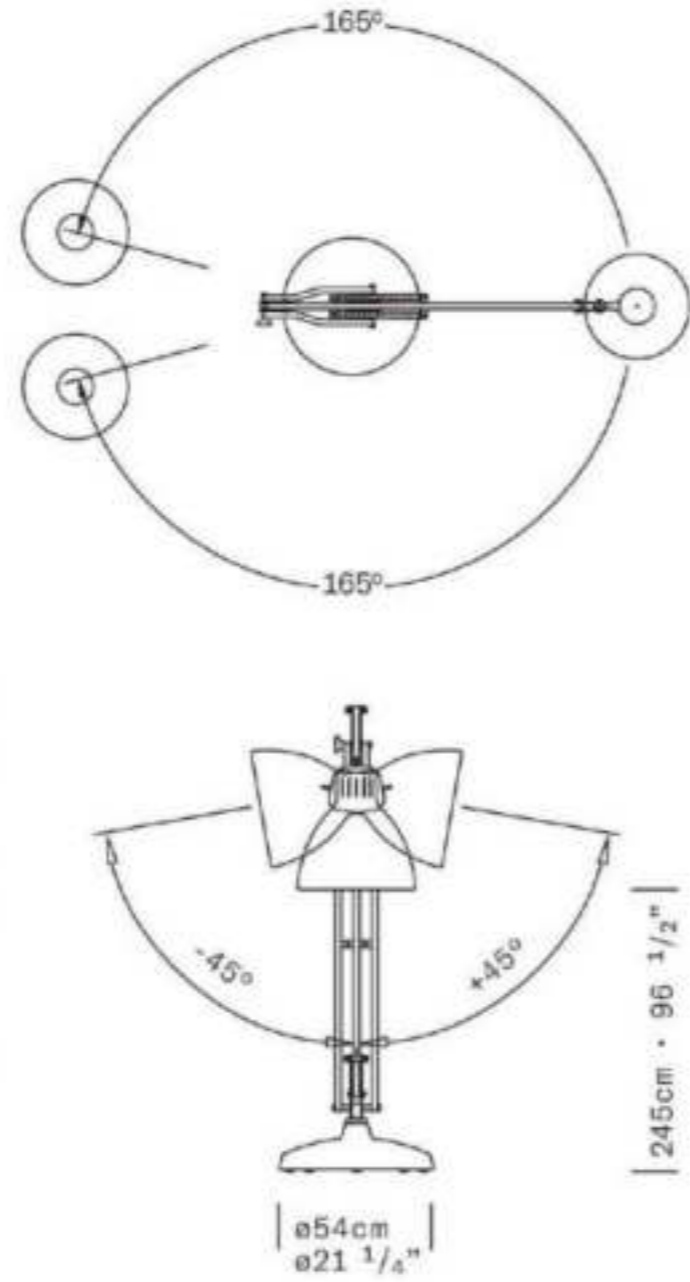
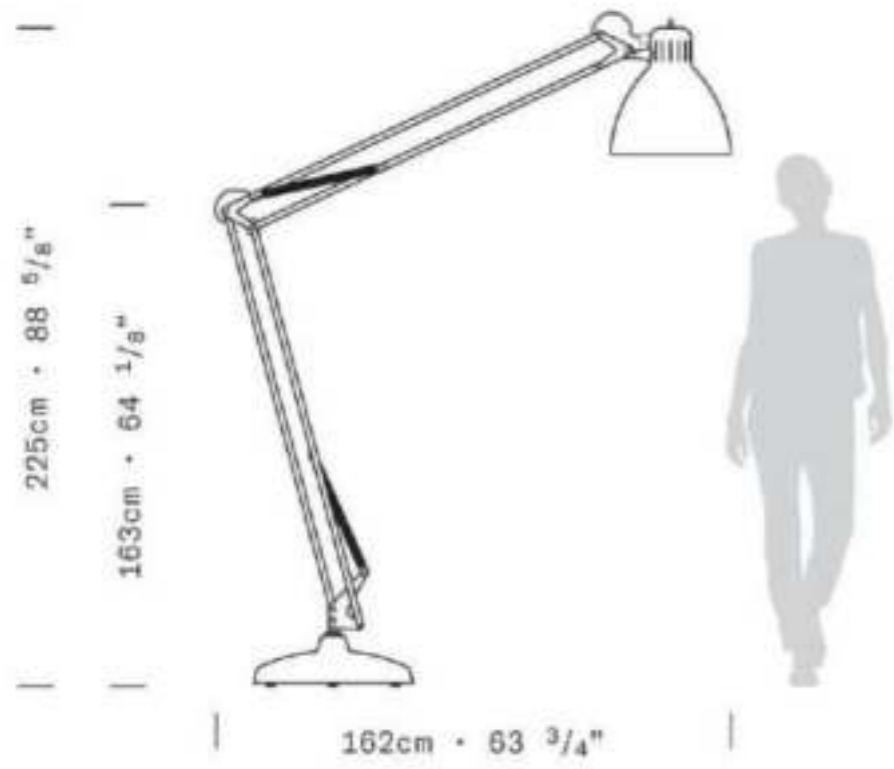



KTRIBE 795

MATERIAL
COLORS

ALUMINIUM/ GLASS
BRUSHED COPPER+CLEAR GLASS/BRUSHED COPPER+CLEAR GLASS



SM795T
Ø 395 x H690



SM795F
Ø 395 x H1620

KTRIBE

Injection-molded PC (polycarbonate) opal inner
diffuser. Outer diffuser in transparent or fumée
PMMA





MERCURY 788

MATERIAL ALUMINIUM/ GLASS
COLORS SILVER GREY CHASSIS/CHROME



SM788C1
Φ 800 x H550



SM788C2
Φ 1100 x H550



SM788S GROUP
L2800 x W1100 x H:2000



SM788S2
Φ 1100 x H550(MAXH2000)







MEIAMPO
777

MATERIAL PC / CARBON STEEL
COLORS BEIGE / RED







SM777W1
 Ø 235 x H146



SM777W2
 Ø 235 x H315



SM777T
 Ø 357 x H560



SM777S1
 Ø 358 x H225



SM777S2
 Ø 550 x H370



SM777F1
 Ø 357 x H1400



SM777F2
 Ø 550 x H1780



GLASS JARS 771

MATERIAL
COLORS

CARBON STEEL GLASS
CLEAR GLAS



SM771S-3
L320 x W320 x H1100



SM771S-5
L890 x W190 x H:480(MAX1100)



SM771S-8
L43.5 x W43.5 x H1200





TWIGGY FLOOR LAMP 733

MATERIAL ALUMINIUM/ FIBER TUBE / CARBON STEE/ACRYLIC
COLORS WHITE/ BLACK/ORANGE



SM733F
L1700 x W600 (MINH1750-MAXH2200)

TWIGGY FLOOR LAMP



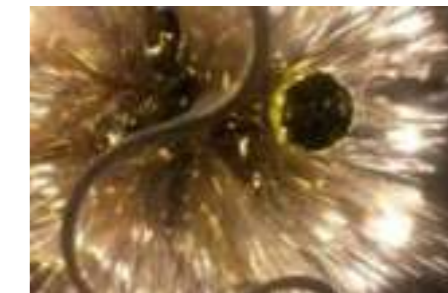

PARISH 730

MATERIAL
COLORS

CARBON STEEL+GLASS
EARL GOLD+CLEAR GLASS /CHROME+SMOKEY GREY



SM73052
Φ:600 H:600



SM73053
Φ:700 H:700





AMIE 716

MATERIAL
COLORS

PC
WHITE/ YELLOW/DARK GREY



716W
L620 x W270 x H350

AAMITE





YELANG
706

MATERIAL
COLORS

CRYSTAL/CARBON STEEL
CLEAR GLASS+SUMMER GOLD



SM705T
Ø 200 x H85 (MAX H2000)





GILL 705

MATERIAL
COLORS

CARBON STEEL+GLASS
CHROMECHROME+CLEAR/CHROME+EARL GOLD+CLEAR GLASS



SM705T
Ø 400 x H480

GILL

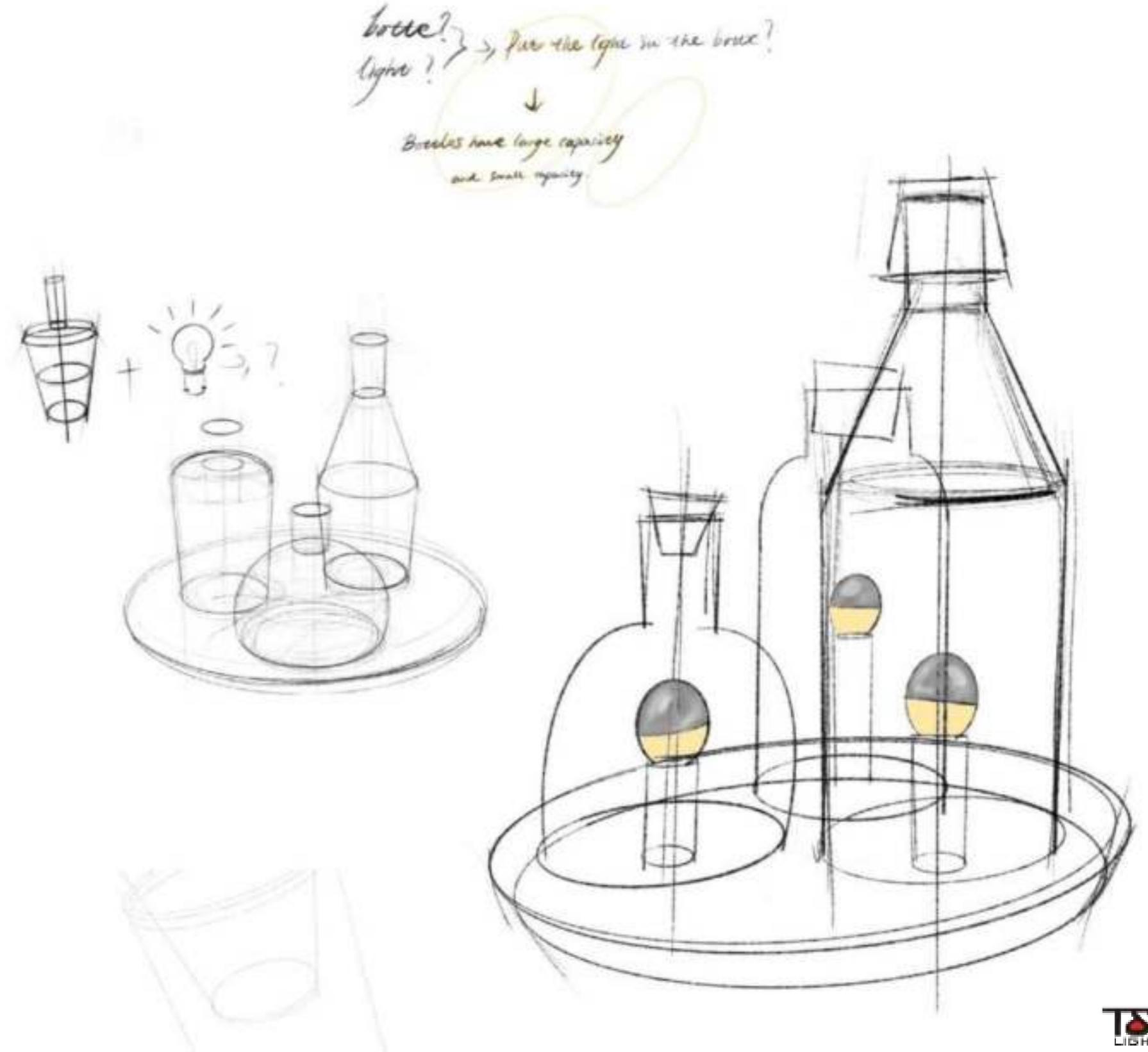



BLOW 703

MATERIAL
COLORS

CARBON STEEL+GLASS
EARL GOLD+CHROME



SM703T1
Ø 170 x H260



SM703T2
Ø 240 x H410

Prodotto da 2012
2012/12

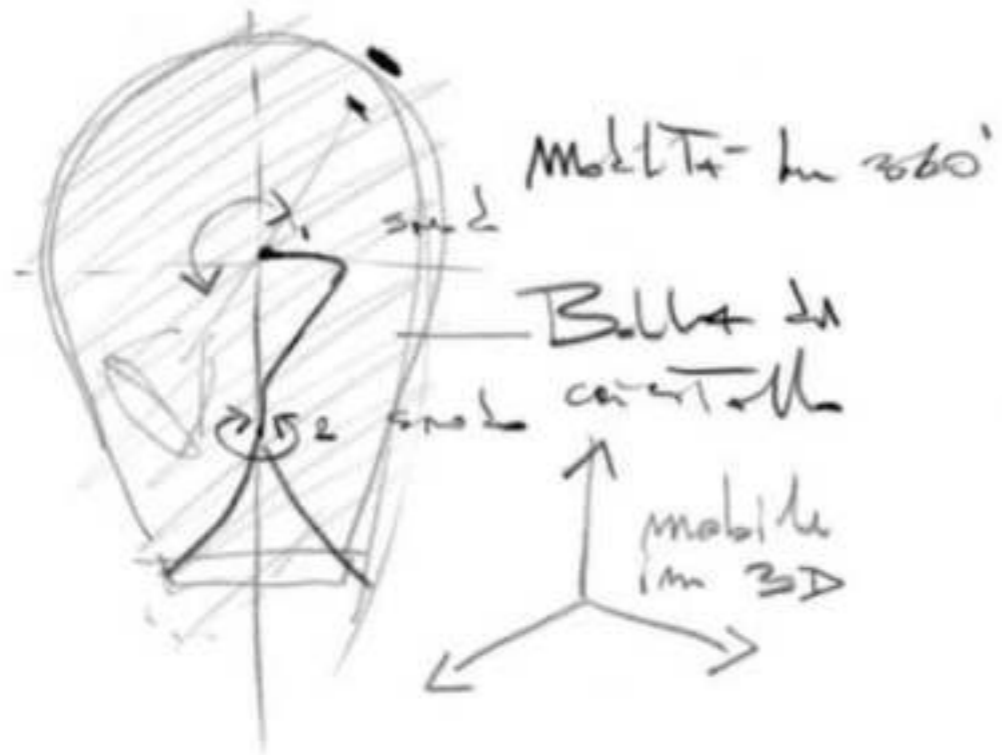
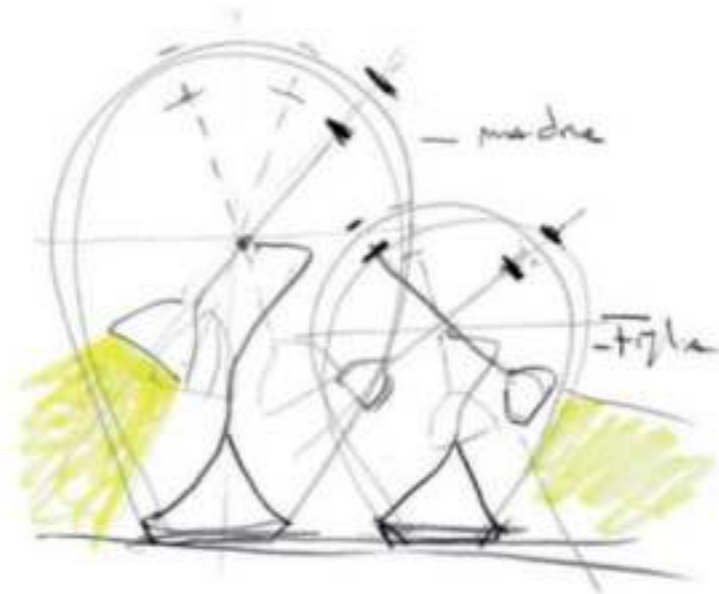



SNOOPY
691

MATERIAL
COLORS

MARBLE/CARBON STEEL
WHITE SHADE /BLACK SHADE



SM691T
Ø 400 x H370

SNOOPY

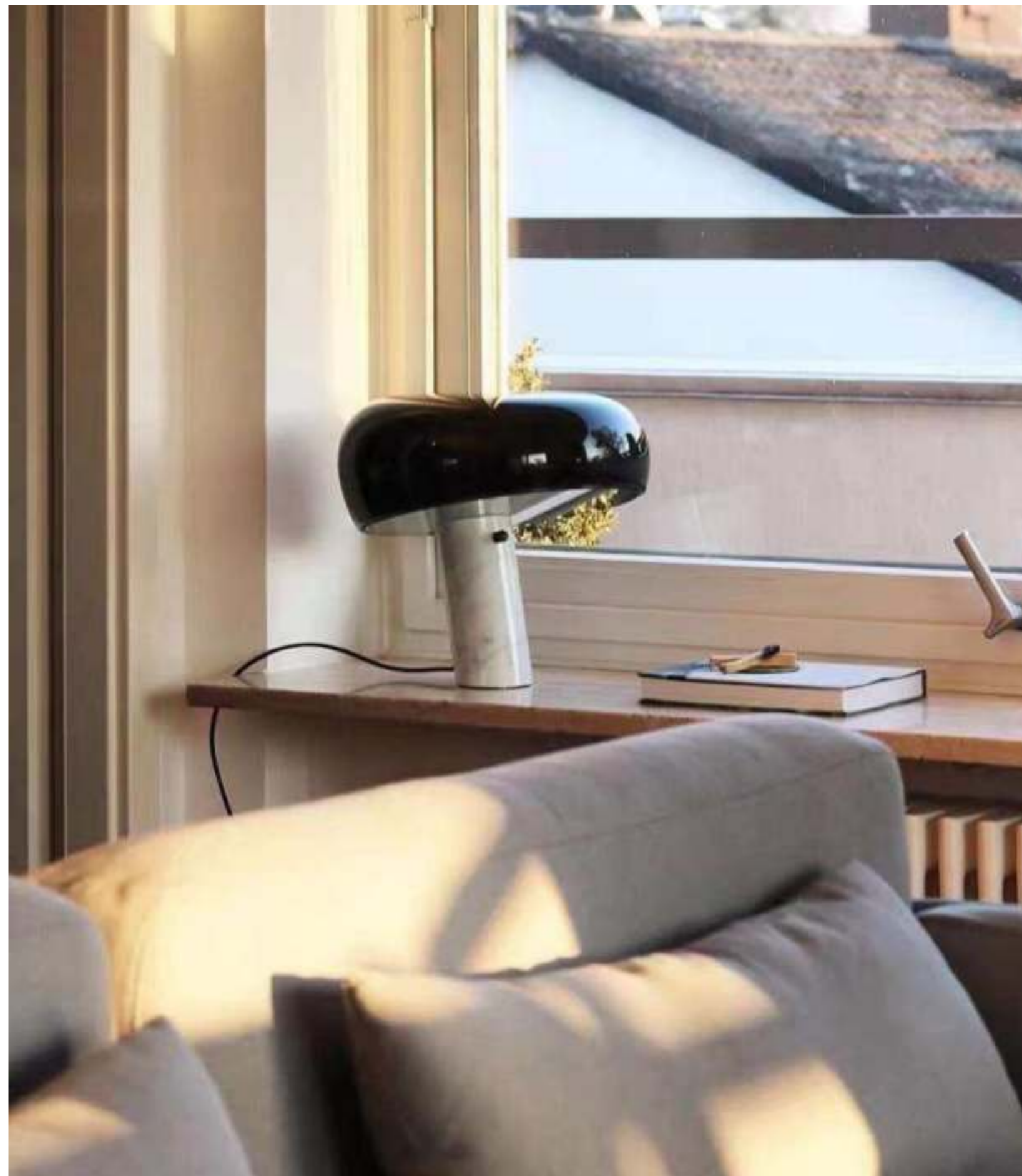



O-SPACE
667

MATERIAL PC
COLORS WHITE/ ORANGE



SM667S
L560 x W425 x H300





SARAH
666

MATERIAL GLASS
COLORS WHITE



SM666T1
Ø 360 x H360



SM666T2
Ø 480 x H480







CABOCHE
665

MATERIAL
COLORS

ACRYLIC/GLASS/CARBON STEEL
TRANSPARENT/ AMBER



CABOCHE





SM665S1
 Ø 350 x H200



SM665S2
 Ø 500 x H200



SM665S3
 Ø 650 x H200



SM665S4
 Ø 800 x H200



SM665T1
 Ø 350 x H400



SM665T2
 Ø 500 x H450



SM665F2
 Ø 500 x H1520



SM665F3
 Ø 650 x H1750



SM665C1
 Ø 350 x H230



SM665C2
 Ø 500 x H230



SM665C3
 Ø 650 x H230



SM665W
 L340 x W200 x H200



GLOBE 661

MATERIAL ACRYLIC
COLORS CHROME+CLEAR+EARL GOLD+CLEAR GLASS



SM661S
Ø 400 x H400(MAX H2000)





CHI
632

MATERIAL
COLORS

GLASS/CARBON STEEL
EARL GOLD+GOLD/CHROME/CLEAR GLASS

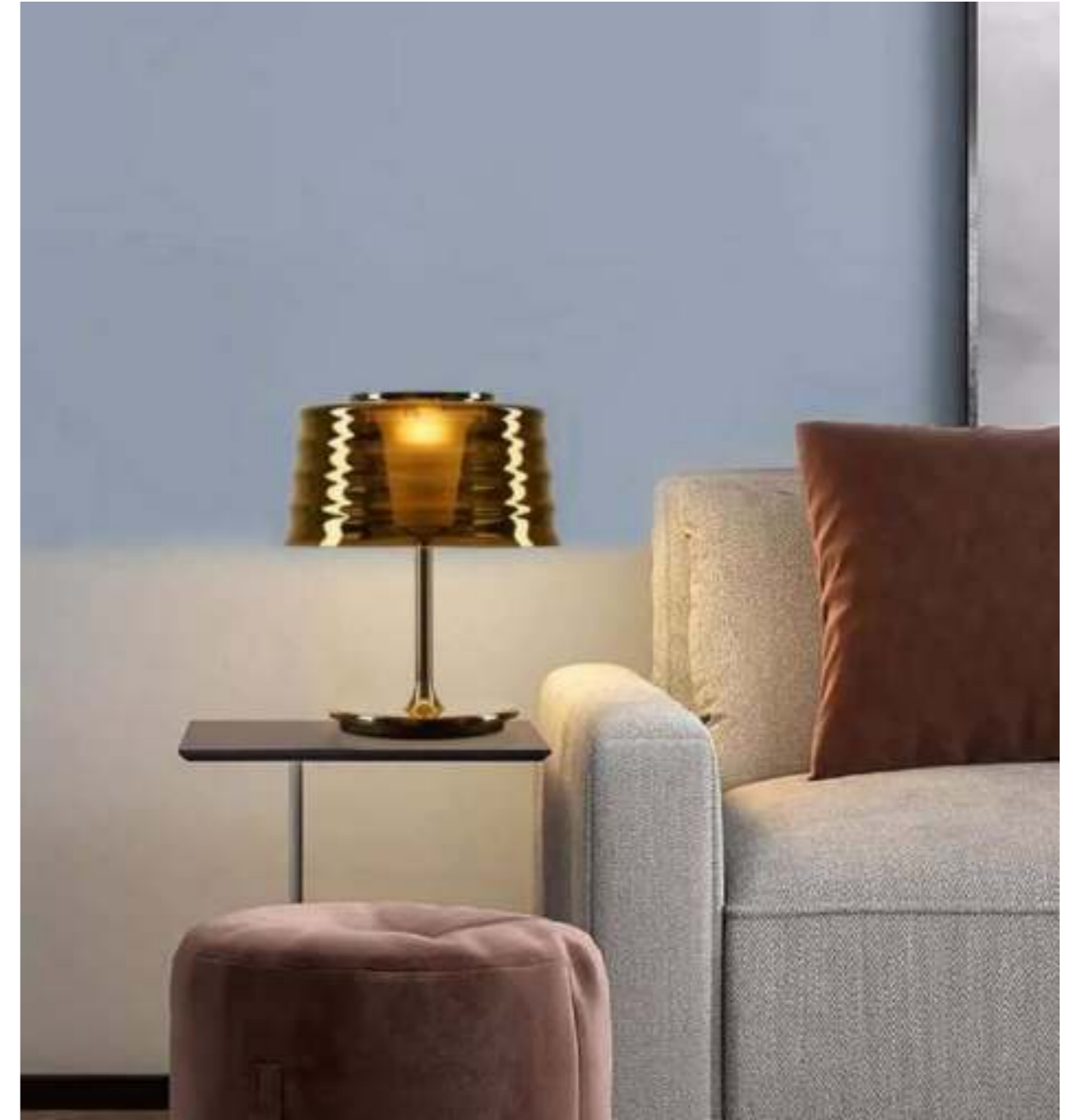



SM632F2
Φ 350 x H1350



SM2632F3
Φ 450 x H1700



SM632T1
Φ 250 x H300



SM632T2
Φ 350 x H420



SM632T3
Φ 450 x H500



SM632S1
Φ 250 x H130



SM632S2
Φ 350 x H180

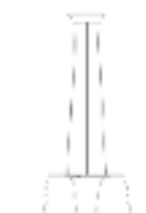

SM632S3
Φ 450 x H220

CHI



DIABOLO 407

MATERIAL ALUMINIUM
COLORS BLACK/ RED/ WHITE



SM407S
Ø 400 x (MIN)H1000

DIAABOLO







GLA-BALL
406

MATERIAL GLASSTEEL
COLORS WHITE



GLA-BALL







SM406S1
Φ140 × H300



SM406S2
Φ250 × H600



SM406S3
Φ350 × H710



SM406S4
Φ420 × H800



SM406T1
Φ140 × H310



SM406T2
Φ250 × H550

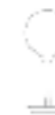

SM406T3
Φ350 × H660



SM406T4
Φ420 × H735



SM406T2-1
Φ250 × H250



SM406T3-1
Φ350 × H350



SM406T4-1
Φ420 × H420



SM406F3
Φ350 × H1800



SM406F4
Φ420 × H1880



NICONOS 343

MATERIAL GLASS CARBON STEEL
COLORS CLEAR GLASS



SM343S1
Φ300 × H480



SM343S2
Φ300 × (MAXH1550)(MINH1050)



SM343W
L250 × W325(SHADE) × H400



SM343T
Φ250 × H600



SM343F
Φ300 × H1780







FRISBI
340

MATERIAL CARBON STEEL+PC
COLORS CHROME+EARL GOLD



SM340S
Ø 600 x H780



FRISBI





TACCIA 329

MATERIAL
COLORS

CARBON STEEL+ALUMINIUM ALLOY+GLASS
SILVER/BLACK/RED



SM328T
Φ 375 x (MAXH520 MINH410)



SM329T
Φ 500 x (MAXH665 MINH525)







FROSTED BULBS 325

MATERIAL CARBON STEEL
COLORS EARL GOLD+STAIN NICKLE



SM325S1
Ø 850 x H 660



SM325S2
Ø 1000 x H 880





FROSTED
BULBS



RHEA 320

MATERIAL
COLORS

ALUMINIUM CARBON STEEL
GREY/ WHITE



SM320S
Ø 485 x H305





PH 2/1
318

MATERIAL CARBON STEEL+GLASS
COLORS CHROME/SUMMER BLACK/CHROME/BRUSHED COPPER



SM318T1
Ø 285 x H455



SM318T2
Ø 445 x H650



SM318F2
Ø 445 x H1530







ARTICHOKE 313

MATERIAL ALUMINIUM CARBON STEE
COLORS WHITE/ PINK



SM313SX
Ø 480 x H520



SM313S1
Ø 600 x H670



SM313S2
Ø 720 x H760





ARTICHOKE
314

MATERIAL
COLORS

ALUMINIUM CARBON STEE
WHITE/ PINK



SM314S2
Φ 1000 x H670





SPUN
306

MATERIAL CARBON STEEL ALUMINIUM
COLORS BLACK/WHITE



SM306T
Ø 390 x H575



SM306F
Ø 500 x H1765





ROSY ANGELIS
273

MATERIAL FABRIC CARBON STEEL
COLORS WHITE



SM273F
Ø 600 x H1780





ROMEO MOON 268

MATERIAL GLASS CARBON STEEL
COLORS CLEAR GLASS



SM268T1
Ø 500 x H730



SM268T2
Ø 500 x H730



SM268F1
Ø 500 x H1600



SM268S2
Ø 500 x H230



STYLOS EUR 252

MATERIAL ACRYLIC CARBON STEEL
COLORS WHITE



SM252F2
Ø 350 x H2040

STYLOS EUR





GLA-BALL 233

MATERIAL WHITE
COLORS GLASS + CARBON STEEL



SM233S
Ø330 x H260



SM233T1
Ø330 x H292

